



AWB
always · wear · better

About us

AWB have been supporting healthcare professionals and patients with scrub suits and garments for over 75 years. In fact, we have been supplying the NHS since before it was the NHS and we are proud to continue to do so.

For more than three quarters of a century AWB have honed and developed our expertise in the healthcare apparel sector. As well as our own bespoke range of products we have sought out and selected like-minded brands and suppliers to deliver the high-quality range of products that healthcare professionals have come to expect from our trusted family company.

Innovation runs in the family. Established in 1946 our grandfather, Dennis William Cook saw an opportunity to create a specialist firm to supply the healthcare industry with medical apparel. He acquired A. W. Bent Limited, a well-established hat-lining business in Luton and shifted its focus to the manufacture of healthcare apparel.

The business was relocated to Cornwall in the 1960s and Dennis' sons; Cedric, Bill and Ross continued to take the business forward. The second generation of Cooks to run A. W. Bent introduced additional product lines, diversified the supply chain and grew the business.

In 2023, the business was passed to the third generation of Cooks, (Greg and James) and we are committed to carry on our family's legacy and continue to provide quality products to the healthcare sector.

AWB always.wear.better



Our product range

Navigate our brochure by clicking on your preferred brand.

AWB own brands

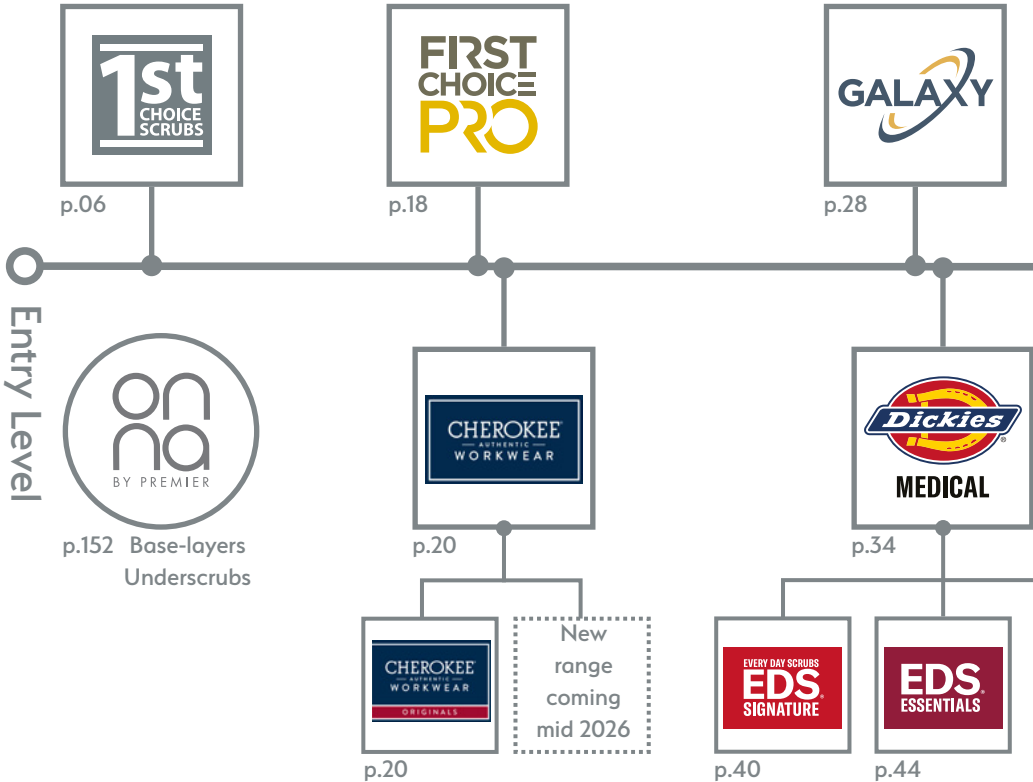

Selected partner brands

Drawing upon over 75 years of industry experience, we at AWB have designed and developed a range of our own bespoke products for healthcare professionals.

Quality is at the heart of our offer and we are continually looking to improve and develop our products in response to new technology, sustainability and valuable feedback from our customers.

To compliment our own brands, AWB have carefully selected a range of partner brands to provide a wide variety of scrub suit uniforms to meet the demands of today's healthcare professionals at every price-point.

AWB always.wear.better

[Click here for garment sizing](#)

p.118

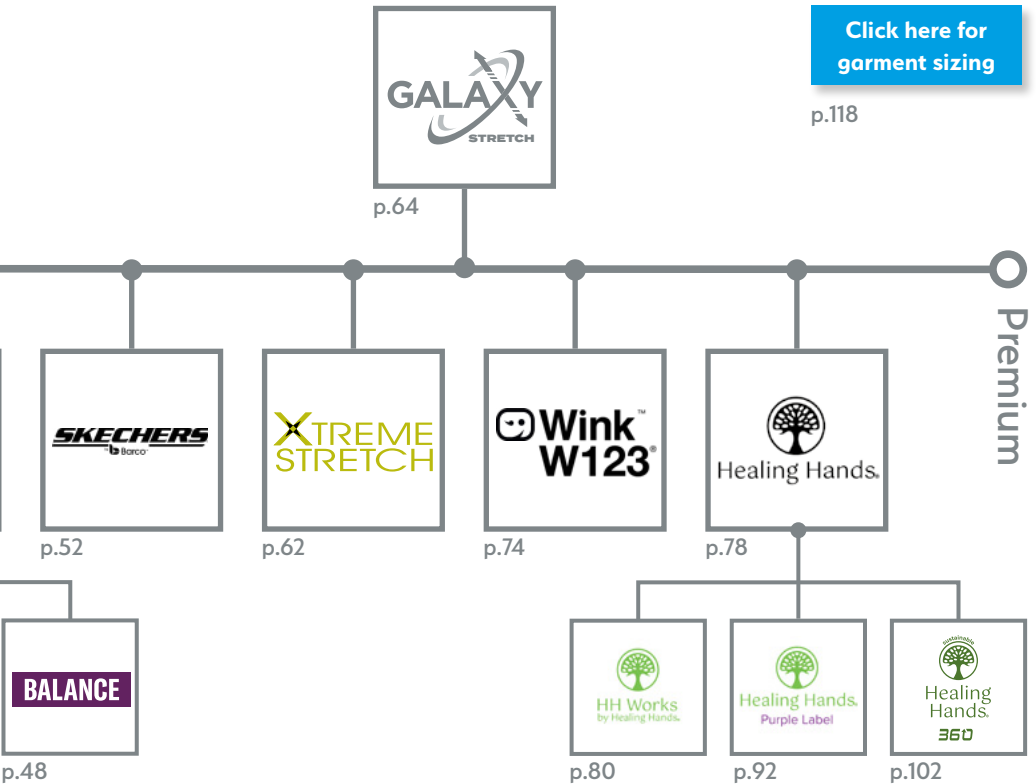



1st Choice Scrubs

1st Choice are AWB's own-brand entry level range of garments and have been the cornerstone of our business since founding.

Tried and tested, our 1st Choice scrubs design has evolved over 75 years to deliver a robust and flexible product able to cope with the rigours of modern healthcare practice and industrial laundering (EN14065 & decontamination HTM-01-05).

Suits are fully **reversible** (that's why there are pockets on the inside too.)

Can be bought as a suit and or separates.

Fit: Unisex

Fabric: 65% polyester
35% cotton

Fabric weight: 130 gsm min

Tunic Top: V-neck
Fully reversible
1x hip pocket
inside & out
Coloured sizing trim
around neck

Trousers/Pant: Fully reversible
1x rear pocket
inside and out
Coloured drawstring
for sizing

Checkout our base-layers and underscrubs on the back page.

Personalise your uniform with our in-house embroidery service.

[Click here for garment sizing](#)

available sizes & trim key:



available colours:





Models are wearing Navy.
Models are wearing under-scrubs.





1st Choice Warm-up jacket

1st Choice are AWB's own-brand entry level range of garments and have been the cornerstone of our business since founding.

Our warm-up jackets offer an extra layer of warmth when moving between theatre and ward, or for nipping out to your favourite coffee shop mid shift. The 1st Choice warm-up jacket is suitable for industrial laundering (EN14065 & decontamination HTM-01-05).

Can be worn with 1st Choice, First Choice PRO and Galaxy scrubs.

Checkout our base-layers and underscrubs on the back page.

Personalise your uniform with our in-house embroidery service.

[Click here for garment sizing](#)

Fit: Unisex

Fabric: 65% polyester
35% cotton

Fabric weight: 130 gsm min

Jacket: Crew neck
Pop-stud fastening
Rib knit elasticated cuffs
2x hip pockets
Coloured sizing trim around neck

available sizes & trim key:



available colours:

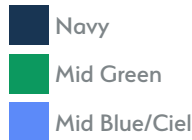

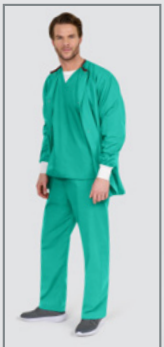
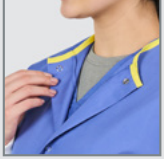

Models are wearing Navy.
Models are wearing under-scrubs.



1st Choice Patient Gown

1st Choice are AWB's own-brand entry level range of garments and have been the cornerstone of our business since founding.

Our Blue Diamond Print Patient Gown, is 46" long and generously cut for extra comfort. Also featuring ties at the back and an overlapping modesty panel.

The 1st Choice Patient Gown is suitable for industrial laundering (EN14065 & decontamination HTM-01-05).

Personalise your uniform with our in-house embroidery service.

[Click here for garment sizing](#)

Fit: Unisex

Fabric: 65% polyester
35% cotton

Fabric weight: 145 gsm min

Gown: Full length gown
Wrap around design
Large overlap for modesty
2x neck/shoulder ties
2x waist ties

available sizes:

Standard size

Bariatric size

available colours:



Blue Diamond/White trim
(Standard)



Green Diamond/Green Trim
(Bariatric)







1st Choice Patient Robe

1st Choice are AWB's own-brand entry level range of garments and have been the cornerstone of our business since founding.

Our Blue Diamond Print Patient Robe, is generously cut for extra comfort. Patient dignity is important and this garment is designed for maximum modesty and made from a comfortable 65/35 Poly/Cotton.

The 1st Choice Patient Robe is suitable for industrial laundering (EN14065 & decontamination HTM-01-05).

Personalise your uniform with our in-house embroidery service.

[Click here for garment sizing](#)

Fit: Unisex

available sizes & trim key:

Fabric: 65% polyester
35% cotton

Single size

Fabric weight: 145 gsm min

available colours:

Robe: Mid length robe
Wrap around design
Large overlap for modesty
1x waist tie



Blue Diamond Swatch





Model is wearing Blue Diamond Gown underneath Robe.



1st Choice Mammography Cape

1st Choice are AWB's own-brand entry level range of garments and have been the cornerstone of our business since founding.

Our Mammography cape provides dignity and functionality for female patients when attending Mammogram screening. The garment is made from a comfortable 65/35 Poly/Cotton.

The 1st Choice Mammography Cape is suitable for industrial laundering (EN14065 & decontamination HTM-01-05).

Fit: Female

available sizes & trim key:

Fabric: 65% polyester
35% cotton

Single size

Fabric weight: 145 gsm min

available colours:

Cape: White hem and collar
Velcro fastening at neck



Blue Diamond Swatch



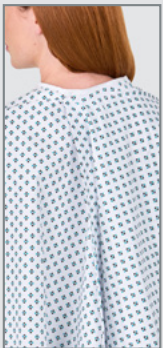

Model is wearing Galaxy Stretch
0600 trousers.



1st Choice Ortho Gown

1st Choice are AWB's own-brand entry level range of garments and have been the cornerstone of our business since founding.

The 1st Choice Ortho Gown is manufactured with cuffed sleeves help to prevent contamination from skin particles. It is designed to wear over normal clothes or one of our scrub suits.

Multi-launderable with excellent barrier properties throughout the garment's life. Suitable for industrial laundering (EN14065 & decontamination HTM-01-05).

Fit: Unisex

available sizes & trim key:

Fabric: 65% polyester
35% cotton

Single size

Fabric weight: 145 gsm min

available colours:

Gown: Elasticated cuffs
Ties as back
Tie at waist

 [Mid Green](#)

 [Mid Blue/Ciel](#)





Model is wearing Galaxy Stretch
0600 trousers.

First Choice PRO Scrubs

First Choice PRO retains the industrial laundering performance of our 1st Choice brand, but offers enhanced functionality and affordability. Many of our customers choose First Choice PRO as an alternative to Cherokee.

The range draws upon the sizing and fit of our Galaxy range including the hybrid waist of the trousers. The First Choice PRO is suitable for industrial laundering (EN14065 & decontamination HTM-01-05).

Can be bought as a suit and or separates.

Fit: Unisex
Fabric: 65% polyester
35% cotton

Fabric weight: 145 gsm

Tunic Top: V-neck
2x hip pockets
Side vents
Colour coded label in neck

Trousers/Pant: 1x rear pocket
1x cargo pocket
Elasticated draw-string waist
Available in TALL and SHORT fits
Colour coded label

Checkout our base-layers and underscrubs on the back page.

Personalise your uniform with our in-house embroidery service.

[Click here for garment sizing](#)

available sizes & trim key:



available colours:

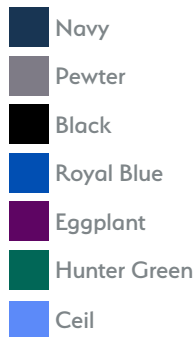



Models are wearing Pewter.
Models are wearing under-scrubs.



Originals 4700 Top & 4200 Pant

Cherokee Originals is one of our most popular partner brands. Widely recognised across the industry as being lightweight, robust and easy care.

Available in a wide range of colours enables tunic tops and trousers to be mixed and matched across the range to create multiple aesthetic combinations.

Suitable for industrial laundering . Can be bought as a suit and or separates.

Checkout our base-layers and underscrubs on the back page.

Personalise your uniform with our in-house embroidery service.

[Click here for garment sizing](#)

Fit: Unisex

Fabric: 65% polyester
35% cotton

available sizes: (extra sizes by request)

XS S M L XL 2XL 3XL

available colours: (extra colours by request)

[4700 Tunic Top:](#) V-neck
Traditional fit
2x hip pockets
1x phone pocket
Side vents

[4200 Trousers/ Pant:](#) Elasticated waist
Traditional fit
Tapered leg
2x cargo pockets
1x phone pocket
1x scissor pocket

-  Navy
-  Wine
-  Pewter
-  Grape
-  Black
-  Caribbean
-  Royal Blue
-  Shocking Pink
-  Turquoise
-  Teal
-  Mid Blue/Ciel
-  Red
-  Hunter Green
-  White
-  Light Grey
-  Eggplant
-  Galaxy Blue
-  Surgical Green





Models are wearing Turquoise & Teal





Originals 4876 & 4100

Cherokee Originals is one of our most popular partner brands. Widely recognised across the industry as being lightweight, robust and easy care.

Available in a wide range of colours enables tunic tops and trousers to be mixed and matched across the range to create multiple aesthetic combinations.

Suitable for industrial laundering. Can be bought as a suit and or separates.

Checkout our base-layers and underscrubs on the back page.

Personalise your uniform with our in-house embroidery service.

[Click here for garment sizing](#)

Fit: Unisex

Fabric: 65% polyester
35% cotton

available sizes: (extra sizes by request)

XS S M L XL 2XL 3XL

available colours: (extra colours by request)

[4876 Tunic Top:](#) V-neck
Denoted by asterisk*
Traditional fit
1x chest pocket
2x hip pockets
1x phone pocket
Side vents

[4100 Trousers/ Pant:](#) Drawstring waist
Traditional fit
Straight leg
2x cargo pockets
1x phone pocket
1x scissor pocket

-  Navy*
-  Wine*
-  Pewter*
-  Grape
-  Black*
-  Caribbean*
-  Royal Blue
-  White
-  Light Grey
-  Teal
-  Mid Blue/Ciel
-  Eggplant
-  Hunter Green



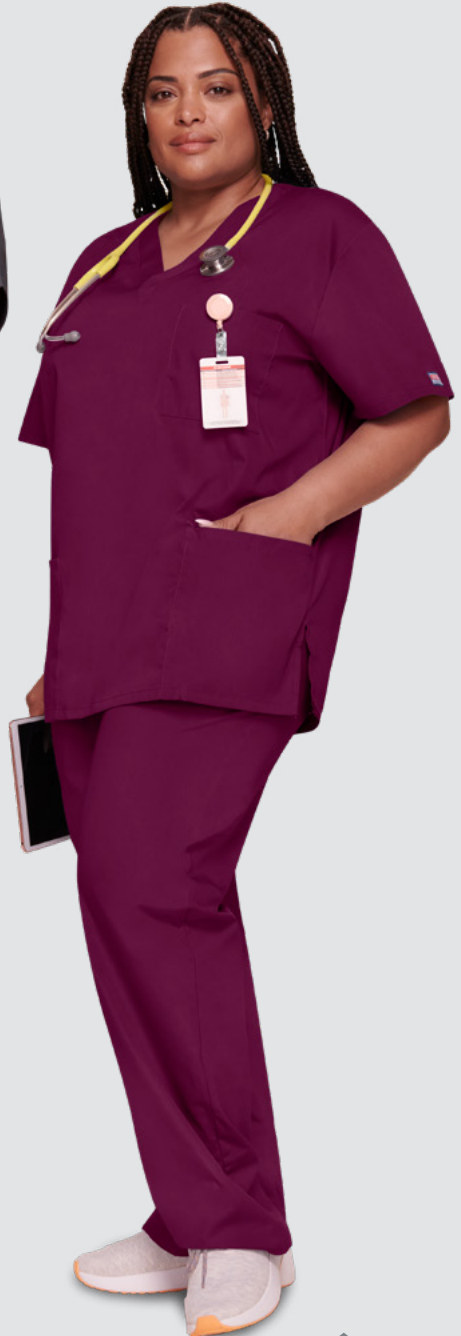
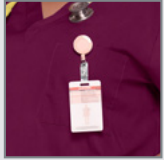

Models are wearing Pewter & Wine.



Revolution Maternity 688 & 155

Cherokee is one of our most popular partner brands. Widely recognised across the industry as being lightweight, robust and easy care.

With 2 way-stretch soft fabric, the Cherokee Revolution Maternity top and trousers will give you freedom of movement as you grow with your baby.

Suitable for industrial laundering. Can be bought as a suit and or separates.

Checkout our base-layers and underscrubs on the back page.

Personalise your uniform with our in-house embroidery service.

[Click here for garment sizing](#)

Fit: Female Maternity



Fabric: 78% polyester
20% rayon
2% spandex

available sizes: (extra sizes by request)

XS S M L XL 2XL 3XL

[688 Tunic Top:](#) Mock wrap v neck
2-way stretch fabric
2x hip pockets
Zip side vents and stretch panels which grow with you and your baby.

available colours: (extra colours by request)

 Navy
 Pewter
 Black

[155 Trousers/ Pant:](#) Elasticated waist
Stretch waist panel
Straight leg
2x cargo pockets
1x zip cargo pocket
2x ID loops



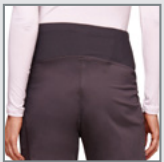
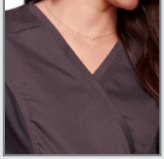



Revolution Maternity 685 & 220

Cherokee is one of our most popular partner brands. Widely recognised across the industry as being lightweight, robust and easy care.

With 2 way-stretch fabric, the Cherokee Revolution Maternity top and trousers will give you freedom of movement as you grow with your baby. This product has been replaced by the 688 & 155.

Suitable for industrial laundering. Can be bought as a suit and or separates.

Checkout our base-layers and underscrubs on the back page.

Personalise your uniform with our in-house embroidery service.

Fit: Female Maternity





Fabric: 63% polyester
34% cotton
3% spandex

available sizes: (subject to stock)

XS S M L XL 2XL 3XL

685 Tunic Top: Mock wrap v neck
2x hip pockets
1x phone pocket
Soft stretchy side panels which grow with you and your baby.

available colours: (subject to stock)

-  Navy
-  Pewter
-  Hunter Green
-  Mid Blue/Ciel

220 Trousers/ Pant: Elasticated waist
Stretch waist panel
Straight leg
2x cargo pockets
1x phone pocket
1x back pocket





Model is wearing Navy.

GALAXY Galaxy Scrubs

Galaxy is AWB's in-house premium range with high quality and durable 175 gsm fabric. A wide selection of colours provides a wide range of aesthetic options whilst retaining the industrial launderable performance. Many of our customers choose Galaxy as an alternative to Dickies EDS.

The range features hybrid waist trousers. The Galaxy range is suitable for industrial laundering (EN14065 & decontamination HTM-01-05).

Can be bought as a suit and or separates.

Fit: Unisex
 Fabric: 65% polyester
 35% cotton

Fabric weight: 175 gsm

Tunic Top: V-neck
 2x hip pockets
 Side vents

Trousers/Pant: 2x hip pockets
 2x cargo pockets
 1x inset cargo pocket
 1x rear pocket
 Elasticated
 draw-string waist
 faux fly
 Available in TALL
 and SHORT fits

Checkout our base-layers and underscrubs on the back page.

Personalise your uniform with our in-house embroidery service.

[Click here for garment sizing](#)

available sizes:

XS S M L XL 2XL 3XL

available colours:

	Navy		Wine
	Pewter		Iris
	Black		Orchid
	Royal Blue		
	Turquoise		
	Mid Blue/Ciel		
	Hunter Green		
	Light Grey		
	Shocking Pink		





Models are wearing Royal Blue.
Models are wearing under-scrubs.



Galaxy Mock-wrap top

Galaxy is AWB's in-house premium range with high quality and durable 175 gsm fabric. A wide selection of colours provides a wide range of aesthetic options whilst retaining the industrial launderable performance. Many of our customers choose Galaxy as an alternative to Dickies EDS.

The Galaxy range is suitable for industrial laundering (EN14065 & decontamination HTM-01-05).

The mock-wrap top can be worn with Galaxy scrub trousers.

Checkout our base-layers and underscrubs on the back page.

Personalise your uniform with our in-house embroidery service.

[Click here for garment sizing](#)

Fit: Female

Fabric: 65% polyester
35% cotton

Fabric weight: 175 gsm

Tunic Top: Crossover V-neck
2x hip pockets
1x inset pocket
Side vents
Tie back
Contrasting piping
1x pen pocket section

available sizes:

XS S M L XL 2XL 3XL

available colours:[contrasting piping]:

-  Navy [ciel blue]
-  Wine [black]
-  Pewter [light grey]
-  Iris [orchid]
-  Black [pewter]
-  Black [pink]
-  Royal Blue [black]
-  Orchid [iris]
-  Turquoise [white]
-  Ciel [navy]
-  Hunter Green [black]
-  Light Grey [pewter]
-  Shocking Pink [black]





Model is wearing Hunter Green.
Models is wearing under-scrub.



Galaxy Healthcare tunic

Galaxy is AWB's in-house premium range. Our healthcare tunic is a durable fitted garment made from a hard wearing and durable polyester/cotton blend.

Available in a wide selection of colours with multiple pockets, the garment has industrial launderable performance (EN14065 & decontamination HTM-01-05).

Can be worn with 1st Choice, First Choice PRO, Galaxy scrub and Galaxy Super trousers.

Checkout our base-layers and underscrubs on the back page.

Personalise your uniform with our in-house embroidery service.

[Click here for garment sizing](#)

Fit: Female

Fabric: 65% polyester
35% cotton

Fabric weight: 195-200 gsm

Tunic Top: Contrasting trim at neck and sleeves
Comfortable fit with double vents back for ease of movement
2x hip pockets
2x chest pockets (left pocket with waterproof lining)
Concealed pop-stud fastening with zip upper

available sizes:

8	10	12	14	16	18	20
22	24	26	28	30	32	

available colours:

-  White
-  Mid Blue
-  Dark Royal Blue
-  Navy
-  Purple
-  Lilac
-  Bottle Green



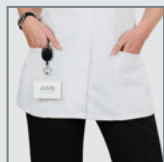
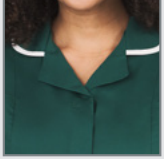

Model is wearing Mid-Blue.



MEDICAL

HC11601 top, HC53102 pant

AWB were the first UK company to introduce Dickies scrubs to the UK on 2010. We are delighted to continue our partnership with this global partner brand.

Available in a range of colours enables tunic tops and trousers to be mixed and matched to create multiple aesthetic combinations. Suitable for industrial laundering. Can be bought as a suit and or separates.

Please note there are limited colours and sizes in these garments due to our supplier discontinuing these products.

Fit: Female

Fabric: 65% polyester
35% brushed cotton

[HC11601 Tunic Top:](#)
Crossover V-neck
2x hip pockets
1x inset pocket
Side vents
Tie back
Contrasting piping
1x pen pocket section

[HC53102 Trousers/ Pant:](#)
Vented Bootcut Leg
Elasticated waist
2x hip pockets
1x rear pocket
2x cargo pockets

Checkout our base-layers and underscrubs on the back page.

Personalise your uniform with our in-house embroidery service.

[Click here for garment sizing](#)

available sizes (subject to stock):

XS S M L XL 2XL 3XL

available colours [contrasting piping]:

 Navy [ciel blue]	 Wine [black]
 Black [pink]	 Iris [orchid]
 White [white]	 Orchid [iris]
 Royal Blue [black]	
 Turquoise [white]	
 Ciel [navy]	
 Hunter Green [black]	
 Shocking Pink [black]	

Trousers are without piping

Colours are subject to stock



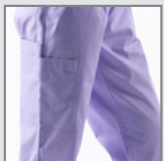
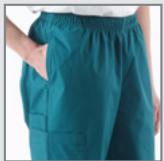



MEDICAL

HC10506 top, HC50601 pant

AWB were the first UK company to introduce Dickies scrubs to the UK on 2010. We are delighted to continue our partnership with this global partner brand.

Available in a range of colours enables tunic tops and trousers to be mixed and matched to create multiple aesthetic combinations. Suitable for industrial laundering. Can be bought as a suit and or separates.

Please note there are limited colours and sizes in these garments due to our supplier discontinuing these products.

Fit: Unisex

Fabric: 65% polyester
35% brushed cotton

[HC10506 Tunic Top:](#)
V-neck
2x hip pockets
Side vents

[HC50601 Trousers/ Pant:](#)
Drawstring waist
2x hip pockets
1x rear pocket
2x cargo pockets
Classic fit

Checkout our base-layers and underscrubs on the back page.

Personalise your uniform with our in-house embroidery service.

[Click here for garment sizing](#)

available sizes (subject to stock):

XS S M L XL 2XL 3XL

available colours (subject to stock):

-  Navy
-  Wine
-  Black
-  Iris
-  White
-  Orchid
-  Royal Blue
-  Turquoise
-  Ciel
-  Hunter Green
-  Shocking Pink



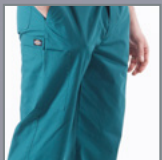
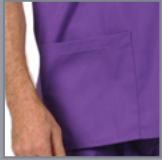
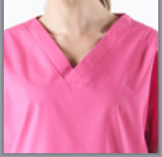

Models are wearing Turquoise & Ciel.



MEDICAL

The Dickies EDS range

AWB were the first UK company to introduce Dickies scrubs to the UK on 2010. We are delighted to continue our partnership with this global partner brand.

The Dickies Medical range is split into 3 sub-brands:

EDS Signature
EDS Essentials
Balance

Available in a range of colours enables tunic tops and trousers to be mixed and matched to create multiple aesthetic combinations. Can be bought as a suit and or separates.

The ranges is as follows:



Every Day Scrubs (EDS) Signature Range is the entry level Dickies Medical Range. Made from a robust polyester/cotton fabric blend, the garments do exactly what they say on the tin. They will deliver a breathable high quality finish for the demanding environment, day-in and day-out. Available in a wide range of colours.



Every Day Scrubs (EDS) Essentials is an evolution of the Signature range and introduces female and male fit garments which have a 4-way stretch, wrinkle-free polyester fabrics. This gives an enhanced level of comfort and movement within the garment. The fabrics also feature moisture wicking technology.



The Dickies Balance range builds upon the principles of EDS Essentials by offering an enhanced softer fabric whilst still retaining a 2-way stretch element to focus upon providing user comfort.





Model is
wearing
Wine.





86706 top, 86106 pant

AWB were the first UK company to introduce Dickies scrubs to the UK on 2010. We are delighted to continue our partnership with this global partner brand. Dickies EDS Signature range is the durable and comfortable entry level range from Dickies.

Available in a range of colours enables tunic tops and trousers to be mixed and matched to create multiple aesthetic combinations. Suitable for industrial laundering. Can be bought as a suit and or separates.

Checkout our base-layers and underscrubs on the back page.

Personalise your uniform with our in-house embroidery service.

[Click here for garment sizing](#)

Fit: Unisex
Fabric: 45% polyester
55% brushed cotton

available sizes: (extra sizes by request)

- XS S M L XL 2XL 3XL

available colours: (extra colours by request)

- Navy Ciel
- Pewter Teal
- Black
- Royal Blue
- Wine
- Caribbean
- Hunter Green
- Eggplant

86706 Tunic Top: V-neck
Traditional fit
2x hip pockets
1x phone pocket
Side vents

86106 Trousers/ Pant: Elasticated waist
Modern Classic fit
Tapered leg
2x cargo pockets
1x phone pocket
1x scissor pocket







83706 top, 83006 pant

AWB were the first UK company to introduce Dickies scrubs to the UK on 2010. We are delighted to continue our partnership with this global partner brand. Dickies EDS Signature range is the durable and comfortable entry level range from Dickies.

Available in a range of colours enables tunic tops and trousers to be mixed and matched to create multiple aesthetic combinations. Suitable for industrial laundering. Can be bought as a suit and or separates.

Checkout our base-layers and underscrubs on the back page.

Personalise your uniform with our in-house embroidery service.

[Click here for garment sizing](#)











Fit: Unisex
Fabric: 45% polyester
55% brushed cotton

available sizes: (extra sizes by request)

XS S M L XL 2XL 3XL

83706 Tunic Top: V-neck
Traditional fit
1x chest pockets
1x pen insert pocket
ID loop

available colours: (extra colours by request)

-  Navy
-  Ciel
-  Pewter
-  Teal
-  Black
-  Royal Blue
-  Wine
-  Caribbean
-  Hunter Green
-  Eggplant

83006 Trousers/
Pant: Drawstring waist
Traditional fit
Standard leg
1x rear pocket







DK625 top, DK010 pant

AWB were the first UK company to introduce Dickies scrubs to the UK on 2010. We are delighted to continue our partnership with this global partner brand.

Dickies EDS Essentials is a breathable moisture-wicking, 4-way stretch fabric, ensuring comfort and freedom of movement. Available in a range of colours enables tunic tops and trousers to be mixed and matched to create multiple aesthetic combinations. Not suitable for industrial laundering.

Can be bought as a suit and or separates.

Fit: Female Contemporary

Fabric: 95% polyester
5% spandex

DK625 Tunic Top: V-neck mock-wrap
2x hip pockets
1x pen insert pocket
ID loop

DK010 Trousers/
Pant: Drawstring elasticated waist
Standard straight vented leg
2x hip pockets
2x rear pockets
2x cargo pockets
1x cargo insert pocket

Checkout our base-layers and underscrubs on the back page.

Personalise your uniform with our in-house embroidery service.

[Click here for garment sizing](#)

available sizes:



available colours (extra colours by request):

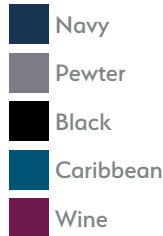

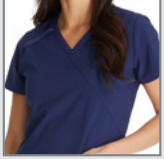



DK645 top, DK015 pant

AWB were the first UK company to introduce Dickies scrubs to the UK on 2010. We are delighted to continue our partnership with this global partner brand.

Dickies EDS Essentials is a breathable moisture-wicking, 4-way stretch fabric, ensuring comfort and freedom of movement. Available in a range of colours enables tunic tops and trousers to be mixed and matched to create multiple aesthetic combinations. Not suitable for industrial laundering.

Can be bought as a suit and or separates.

Fit: Male Contemporary

Fabric: 95% polyester
5% spandex

DK645 Tunic Top: V-neck
2x hip pockets
1x pen insert pocket
1x chest pocket
1x scissor pocket
ID loop

DK015 Trousers/ Pant: Drawstring elasticated button waist with zip fly
Belt loops
Standard straight
2x hip pockets
2x rear pockets
2x cargo pockets

Checkout our base-layers and underscrubs on the back page.

Personalise your uniform with our in-house embroidery service.

[Click here for garment sizing](#)

available sizes:



available colours (extra colours by request):

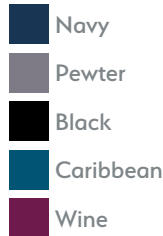





MEDICAL

BALANCE

DK870 top, DK135 pant

AWB were the first UK company to introduce Dickies scrubs to the UK on 2010. We are delighted to continue our partnership with this global partner brand.

Dickies EDS Balance is a soft, breathable, 2-way stretch fabric ensuring comfort and freedom of movement. Available in a range of colours enables tunic tops and trousers to be mixed and matched to create multiple aesthetic combinations. Not suitable for industrial laundering.

Can be bought as a suit and or separates.

Fit: Female Contemporary

Fabric: 77% polyester
20% rayon
3% spandex

DK870 Tunic Top: V-neck soft rib knit neck
2x hip pockets
Soft rib knit back panels
ID loop

DK135 Trousers/ Pant: Drawstring elasticated rib knit waist
Standard tapered leg
2x hip pockets
2x rear pockets
1x cargo pocket
1x zip cargo pocket
Utility loop

Checkout our base-layers and underscrubs on the back page.

Personalise your uniform with our in-house embroidery service.

[Click here for garment sizing](#)

available sizes:

- XS S M L XL 2XL 3XL

available colours (extra colours by request):

- Navy
- Pewter
- Black
- Royal Blue
- Wine







MEDICAL

BALANCE

DK845 top, DK220 pant

AWB were the first UK company to introduce Dickies scrubs to the UK on 2010. We are delighted to continue our partnership with this global partner brand.

Dickies EDS Balance is a soft, breathable, 2-way stretch fabric ensuring comfort and freedom of movement. Available in a range of colours enables tunic tops and trousers to be mixed and matched to create multiple aesthetic combinations. Not suitable for industrial laundering.

Can be bought as a suit and or separates.

Fit: Male Contemporary

Fabric: 77% polyester
20% rayon
3% spandex

DK845 Tunic Top: V-neck soft rib knit neck
1x chest pocket
2x hip pockets
1x pen insert pocket
Soft rib knit side panels

DK220 Trousers/ Pant: Drawstring elasticated rib knit button waist with fly
Standard straight leg
2x hip pockets
1x zip hip insert pocket
2x rear pockets
1x cargo pocket
Utility loop

Checkout our base-layers and underscrubs on the back page.

Personalise your uniform with our in-house embroidery service.

[Click here for garment sizing](#)

available sizes:

- XS S M L XL 2XL 3XL

available colours (extra colours by request):

- Navy
- Pewter
- Black
- Royal Blue
- Wine







Skechers Scrubs

AWB are delighted to be able to make your workday better with Skechers Scrubs.

Combining the renowned comfort and quality you expect from Skechers, these scrubs are designed to keep you feeling and performing your best throughout your shift. Made with innovative, moisture-wicking, and breathable materials, Skechers healthcare uniforms ensure you stay cool and dry, while the stain-release fabric makes cleaning up spills a breeze. Featuring a comfortable 4-way stretch fabric, they provide exceptional freedom of movement for all-day comfort, allowing you to go that extra mile with ease.

But these scrubs aren't just about comfort – they're also an eco-conscious choice. Each set of scrubs (top and trousers) is crafted with recycled content fabric, using approximately 14 recycled plastic bottles. Look and feel your best while doing your part for the planet – choose Skechers today.

Available in sizes XS-2XL and up to 12 colours

Can be bought as a suit and or separates.





Model is
wearing
Black.

Breeze top & Breeze pant

AWB are delighted to offer Skechers scrubs. Combining the renowned comfort and quality you expect from Skechers, these scrubs are made with innovative, moisture-wicking, and breathable materials to ensure you stay cool and dry. Featuring a comfortable 4-way stretch fabric and a stain-release fabric, they provide exceptional freedom of movement for all-day comfort. Each set of scrubs (top and trousers) is crafted with recycled content fabric, using approximately 14 recycled plastic bottles.

Can be bought as a suit and or separates.

Fit: Female

Fabric: 54% polyester
40% recycled polyester
6% spandex with soil release

Breeze Top: [SK101]
V-neck fitted
2x hip pockets
1x hip insert pocket

Breeze Trousers/Pant: [SK202]
Branded soft
Elasticated waistband
Standard vented leg
2x hip pockets
1x cargo pocket with pen insert

Checkout our base-layers and underscrubs on the back page.

Personalise your uniform with our in-house embroidery service.

[Click here for garment sizing](#)

available sizes: (extra sizes by request)

XS S M L XL 2XL

available colours:

	Navy		Grape
	Pewter		Eggplant
	Black		
	Galaxy Blue		
	Bahama		
	Mid Blue/Ciel		
	Hunter Green		
	Wine		
	Teal		

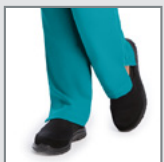
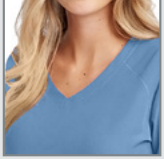

Model is wearing
Bahama.

Reliance top & Reliance pant

AWB are delighted to offer Skechers scrubs. Combining the renowned comfort and quality you expect from Skechers, these scrubs are made with innovative, moisture-wicking, and breathable materials to ensure you stay cool and dry. Featuring a comfortable 4-way stretch fabric and a stain-release fabric, they provide exceptional freedom of movement for all-day comfort. Each set of scrubs (top and trousers) is crafted with recycled content fabric, using approximately 14 recycled plastic bottles.

Can be bought as a suit and or separates.

Fit: Female

Fabric: 54% polyester
40% recycled polyester
6% spandex with soil release

[Reliance Top:](#) Mock-wrap V-neck fitted
[SK102] 2x hip pockets
1x hip insert pocket

[Reliance Trousers/Pant:](#) Hybrid elasticated
[SK201] drawstring waistband
Standard vented leg

2x hip pockets
1x cargo pocket with pen insert

Checkout our base-layers and underscrubs on the back page.

Personalise your uniform with our in-house embroidery service.

[Click here for garment sizing](#)

available sizes: (extra sizes by request)

XS S M L XL 2XL

available colours:

-  Navy
-  Grape
-  Pewter
-  Eggplant
-  Black
-  Galaxy Blue
-  Bahama
-  Mid Blue/Ciel
-  Hunter Green
-  Wine
-  Teal



Structure top & Structure pant

AWB are delighted to offer Skechers scrubs. Combining the renowned comfort and quality you expect from Skechers, these scrubs are made with innovative, moisture-wicking, and breathable materials to ensure you stay cool and dry. Featuring a comfortable 4-way stretch fabric and a stain-release fabric, they provide exceptional freedom of movement for all-day comfort. Each set of scrubs (top and trousers) is crafted with recycled content fabric, using approximately 14 recycled plastic bottles.

Can be bought as a suit and or separates.

Fit: Unisex

Fabric: 54% polyester
40% recycled polyester
6% spandex with soil release

Structure Top: [SK0112]
V-neck
1x chest pocket with
2x chest insert pockets
Part vented sides
Shoulder loop

Structure Trousers/Pant: [SK0215]
Hybrid elasticated
drawstring waistband
Zip fly
Standard leg
2x hip pockets
1x rear pocket
1x cargo pocket
with pen insert

Checkout our base-layers and underscrubs on the back page.

Personalise your uniform with our in-house embroidery service.

[Click here for garment sizing](#)

available sizes: (extra sizes by request)

XS S M L XL 2XL

available colours:

	Navy		Grape
	Pewter		Eggplant
	Black		
	Galaxy Blue		
	Bahama		
	Mid Blue/Ciel		
	Hunter Green		
	Wine		
	Teal		



Model is wearing
Pewter.

Thesis top & Structure jogger

AWB are delighted to offer Skechers scrubs. Combining the renowned comfort and quality you expect from Skechers, these scrubs are made with innovative, moisture-wicking, and breathable materials to ensure you stay cool and dry. Featuring a comfortable 4-way stretch fabric and a stain-release fabric, they provide exceptional freedom of movement for all-day comfort. Each set of scrubs (top and trousers) is crafted with recycled content fabric, using approximately 14 recycled plastic bottles.

Can be bought as a suit and or separates.

Fit: Unisex

Fabric: 54% polyester
40% recycled polyester
6% spandex with soil release

Thesis Top:
[SKT193]

Round-neck
1x chest pocket with pen insert
2x hip pockets-
Part vented sides
Shoulder loop

Structure Jogger Trousers/Pant:
[SKP572]

Hybrid elasticated drawstring waistband
Zip fly
Jogger leg with knit cuff
2x hip pockets
1x cargo pocket

Checkout our base-layers and underscrubs on the back page.

Personalise your uniform with our in-house embroidery service.







[Click here for garment sizing](#)

available sizes: (extra sizes by request)





XS S M L XL 2XL

available colours:

Thesis Top

-  Navy
-  Pewter
-  Black
-  Bahama
-  Royal Blue
-  Hunter Green

Structure Jogger

-  Navy
-  Pewter
-  Black
-  Bahama
-  Mid Blue/Ciel





XTREME
STRETCH

82851 top, DK020 pant

AWB were the first UK company to introduce Dickies scrubs to the UK on 2010. We are delighted to continue our partnership with this global partner brand.

Xtreme stretch is a premium Dickies brand in a soft, breathable, 4-way stretch fabric ensuring comfort and freedom of movement. Available in a range of colours enables tunic tops and trousers to be mixed and matched to create multiple aesthetic combinations. Not suitable for industrial laundering. Can be bought as a suit and or separates.

Checkout our base-layers and underscrubs on the back page.

Personalise your uniform with our in-house embroidery service.

[Click here for garment sizing](#)

Fit: Female Contemporary

Fabric: 75% polyester
21% rayon
4% spandex

available sizes:

XS S M L XL 2XL 3XL

available colours:

-  Navy
-  Teal
-  Pewter
-  Hunter Green
-  Black
-  Wine
-  Royal Blue
-  Eggplant
-  Mid Blue/Ciel
-  Caribbean

82851 Tunic Top: V-neck
Princess Seams
2x hip pockets
1x inset pocket
Front vents
ID loop

DK020 Trousers/ Pant: Drawstring elasticated rib knit waist
Standard vented leg
2x cargo pockets
2x hip pockets
2x rear pockets
ID loop



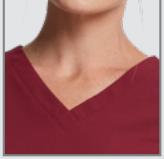

Model is wearing Navy.

Galaxy Stretch

AWB are delighted to introduce [Galaxy Stretch](#); our in-house designed premium scrub range.

Informed by over 75 years of industry expertise, Galaxy Stretch is crafted from a bespoke diamond weave fabric delivering 4-way stretch flexibility. Galaxy Stretch moves with you, providing un-rivalled freedom to extend your reach and go beyond.



Our bespoke fabric blend is breathable, soft, quick drying and easy care, giving you the confidence to remain calm under pressure.

With 200 gsm fabric, you can feel the quality in every stitch and testing to industrial laundry standards ensures that Galaxy Stretch scrubs are ready for every single shift.

The collection is tailored for male and female fits to deliver a comfortable and professional appearance. Standard leg trousers and jogger trousers are available. Sizes range from XS to 3XL with up to 10 colours in selected lines. Galaxy Stretch scrubs can be bought as suits and or separates.

Galaxy Stretch; we've got you covered.







Male 0300 Top & 0100 Jogger

AWB are delighted to introduce [Galaxy Stretch](#); our in-house designed premium scrub range.

The 4-way stretch fabric provides un-rivalled freedom to move as well as being breathable, soft, quick drying and easy care, giving you the confidence to remain calm under pressure. Available in a range of colours enables tunic tops and trousers to be mixed and matched to create multiple aesthetic combinations. Suitable for industrial laundering. Can be bought as a suit and or separates.

Checkout our base-layers and underscrubs on the back page.

Personalise your uniform with our in-house embroidery service.

[Click here for garment sizing](#)

Fit: Male Contemporary

Fabric: 75% polyester
22% rayon
3% spandex

available sizes:

- XS S M L XL 2XL 3XL

available colours:

- Navy
- Pewter
- Black

[0300 Tunic Top](#): V-neck
Short sleeve
1x chest pocket with 1x pen & 1x ID insert
Side vents
Name space in label

[0100 Trousers/ Jogger Pant](#): Drawstring elasticated button waist & zip fly
Jogger cuff leg
2x hip patch pockets
2x rear jeans style pockets
1x cargo pocket
1x cargo phone pocket
Elasticated waist ID loop
Name space in label





Model is wearing Pewter.
Model is wearing Under-scrubs.



Male 0300 Top & 0200 Pant

AWB are delighted to introduce [Galaxy Stretch](#); our in-house designed premium scrub range.

The 4-way stretch fabric provides un-rivalled freedom to move as well as being breathable, soft, quick drying and easy care, giving you the confidence to remain calm under pressure. Available in a range of colours enables tunic tops and trousers to be mixed and matched to create multiple aesthetic combinations. Suitable for industrial laundering. Can be bought as a suit and or separates.

Checkout our base-layers and underscrubs on the back page.

Personalise your uniform with our in-house embroidery service.

[Click here for garment sizing](#)

Fit: Male Contemporary

Fabric: 75% polyester
22% rayon
3% spandex

available sizes:

- XS S M L XL 2XL 3XL

available colours:

- Navy
- Pewter
- Black

[0300 Tunic Top](#): V-neck
Short sleeve
1x chest pocket with 1x pen & 1x ID insert
Side vents
Name space in label

[0200 Trousers/ Standard Pant](#): Drawstring elasticated button waist & zip fly
Standard leg
2x hip pockets
2x rear pockets
1x cargo pocket
1x cargo phone pocket
Elasticated waist ID loop
Name space in label



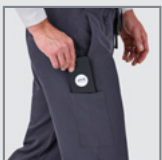
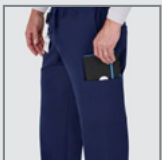

Model is wearing Black.



Female 0400 Top & 0700 Jogger

AWB are delighted to introduce [Galaxy Stretch](#); our in-house designed premium scrub range.

The 4-way stretch fabric provides un-rivalled freedom to move as well as being breathable, soft, quick drying and easy care, giving you the confidence to remain calm under pressure. Available in a range of colours enables tunic tops and trousers to be mixed and matched to create multiple aesthetic combinations. Suitable for industrial laundering. Can be bought as a suit and or separates.

Checkout our base-layers and underscrubs on the back page.

Personalise your uniform with our in-house embroidery service.

[Click here for garment sizing](#)

Fit: Female Contemporary

Fabric: 75% polyester
22% rayon
3% spandex

available sizes:

- XS S M L XL 2XL 3XL

available colours:

- Navy
- Pewter
- Black

[0400 Tunic Top](#): V-neck
Short sleeve
1x chest pocket with 1x pen insert
Side vents
Name space in label

[0700 Trousers/ Jogger Pant](#): Drawstring elasticated soft rib knit waist
Jogger cuff leg
2x hip patch pockets
2x rear jeans style pockets
1x cargo pocket
1x cargo phone pocket
Elasticated waist ID loop
Name space in label



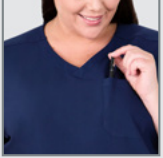



Female 0500 Top & 0600 Pant

AWB are delighted to introduce [Galaxy Stretch](#); our in-house designed premium scrub range.

The 4-way stretch fabric provides un-rivalled freedom to move as well as being breathable, soft, quick drying and easy care, giving you the confidence to remain calm under pressure. Available in a range of colours enables tunic tops and trousers to be mixed and matched to create multiple aesthetic combinations. Suitable for industrial laundering. Can be bought as a suit and or separates.

Checkout our base-layers and underscrubs on the back page.

Personalise your uniform with our in-house embroidery service.

[Click here for garment sizing](#)

Fit: Female Contemporary

Fabric: 75% polyester
22% rayon
3% spandex

available sizes:

XS S M L XL 2XL 3XL

0500 Tunic Top: V-neck, princess seams
Short sleeve
2x hips pockets with 1x pen insert
Side vents
Name space in label

available colours:

-  Navy
-  Teal
-  Pewter
-  Hunter Green
-  Black
-  Wine
-  Royal Blue
-  Eggplant
-  Mid Blue/Ciel
-  Caribbean

0600 Trousers/ Standard Pant Drawstring elasticated soft rib knit waist
Standard vented leg
2x hip pockets
2x rear pockets
1x cargo pocket
1x cargo phone pocket
Elasticated waist ID loop
Name space in label





Established in 1920, Wink are an internationally recognised quality brand of scrubs. The W123 collection is made with a four-way stretch fabric that wicks away moisture to keep you cool, dry, and confident. It's easy-care and provides everyday style and performance.

AWB are delighted to add the Wink brand to our collection of scrubs.

Wink's modern fit skims the body for a fit that is not too tight and not too loose.

Checkout our base-layers and underscrubs on the back page.

Personalise your uniform with our in-house embroidery service.

[Click here for garment sizing](#)

Fit: Female Modern
Fabric: 100% polyester

available sizes:

XS S M L XL 2XL 3XL

[6155 Tunic Top:](#) V-neck
Side vents
2x hip pockets
2x inset hip pockets
Pen section pocket
ID loop
Yoke loop on shoulder

available colours:

 Navy
 Pewter
 Black

[5155 Trousers/ Pant:](#) Drawstring elasticated hybrid waist
Standard vented leg
2x hip pockets
2x rear pockets w/pen
2x cargo pockets
1x inner cargo phone pocket

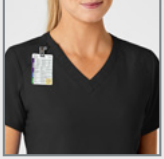

Established in 1920, Wink are an internationally recognised quality brand of scrubs. The W123 collection is made with a four-way stretch fabric that wicks away moisture to keep you cool, dry, and confident. It's easy-care and provides everyday style and performance.

AWB are delighted to add the Wink brand to our collection of scrubs.

Wink's modern fit skims the body for a fit that is not too tight and not too loose.

Fit: Male Modern

Fabric: 100% polyester

[6355 Tunic Top:](#) V-neck
Side vents
2x hip pockets
1x chest pocket
1x sleeve pen pocket
ID loop
Yoke loop on shoulder

[5355 Trousers/
Pant:](#) Drawstring elasticated
hybrid waist with button
Zip fly
Standard vented leg
2x hip pockets
2x rear pockets w/pen
2x cargo pockets
1x inner cargo phone
pocket

Checkout our
base-layers and
underscrubs on
the back page.

Personalise your
uniform with
our in-house
embroidery
service.

[Click here for
garment sizing](#)

available sizes:



available colours:



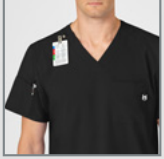



Healing
Hands®

The Healing Hands range

AWB are delighted to offer Healing Hands as our premium range of scrubs.

Embodying our ethos of seeking to always wear better, the 3 Healing Hands ranges we supply offer un-rivalled comfort and style in both female and male fits.

The modern fabrics of Healing Hands provide freedom of movement, breathable, easy care and durable garments. Available in a range of colours enables tunic tops and trousers to be mixed and matched to create multiple aesthetic combinations. Can be bought as a suit and or separates.

The ranges is as follows:



HH Works
by Healing Hands.

With the **HH Works** collection, you work all day long, so you need scrubs that can keep up. Made from a soft blend of four-way stretch polyester and spandex to be lightweight, breathable, durable, and stylish. This modern fit collection features soft, lightweight stretch fabric that promotes comfort and mobility while quickly wicks away moisture.



Healing Hands.
Purple Label

Look Good, Feel Great. That's why the **Healing Hands Purple Label** scrubs were created. Made from a polyester-rayon-spandex stretch blend that promotes comfort and mobility, this innovative fabric creates a completely unique user experience that's designed to carry you through your workday.



Healing Hands.
360

We are proud that the **Healing Hands 360** collection is made with recycled polyester fabric. The result is an easy care 4-way stretch fabric that's strong, wrinkle and fade resistant – and sustainable. When you wear our clothes, you'll be wearing something that was once part of a plastic bottle but now has been reborn into your new favourite piece of clothing. This collection is our premium athleisure line.



AWB
always wear better



Model is
wearing
Navy.





HH Works

HH Works
by Healing Hands.

AWB are delighted to offer Healing Hands as our premium range of scrubs.

With the **HH Works** collection, you work all day long, so you need scrubs that can keep up. Made from a soft blend of four-way stretch polyester and spandex to be lightweight, breathable, durable, and stylish. This modern fit collection features soft, lightweight stretch fabric that promotes comfort and mobility while quickly wicks away moisture.

The modern fabrics of Healing Hands provide freedom of movement, breathable, easy care and durable garments. Available in a range of colours enables tunic tops and trousers to be mixed and matched to create multiple aesthetic combinations. Can be bought as a suit and or separates.





Model is
wearing
Ciel.





HH Works
by Healing Hands.

Monica top & Rebecca pant

AWB are delighted to offer Healing Hands as our premium range of scrubs. With the **HH Works** collection, you work all day long, so you need scrubs that can keep up. Made from a soft blend of four-way stretch polyester and spandex to be lightweight, breathable, durable, and stylish. This modern fit collection features soft, lightweight stretch fabric that promotes comfort and mobility while quickly wicks away moisture.

Can be bought as a suit and or separates.

Checkout our base-layers and underscrubs on the back page.

Personalise your uniform with our in-house embroidery service.

[Click here for garment sizing](#)

Fit: Female

Fabric: 91% polyester
9% spandex

[Monica Top:](#)
[2500]
V-neck fitted
2x hip pockets
2x hip insert pockets
Side vents
Internal garment loop

[Rebecca](#)
[Trousers/Pant:](#)
[9560]
Elasticated
drawstring waistband
Standard leg
2x zip hip pockets
2x cargo pockets on one side with pen insert
Internal garment loop

Available in TALL
and SHORT fits by request

available sizes: (extra sizes by request)

XS S M L XL 2XL

available colours:

 Navy	 Wine
 Pewter	 Khaki
 Black	 Eggplant
 Royal Blue	 White
 Caribbean	
 Mid Blue/Ciel	
 Hunter Green	
 Olive	
 Teal	



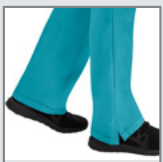
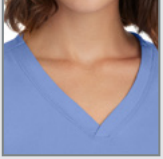



HH Works
by Healing Hands.

Madison top & Renee jogger

AWB are delighted to offer Healing Hands as our premium range of scrubs. With the **HH Works** collection, you work all day long, so you need scrubs that can keep up. Made from a soft blend of four-way stretch polyester and spandex to be lightweight, breathable, durable, and stylish. This modern fit collection features soft, lightweight stretch fabric that promotes comfort and mobility while quickly wicks away moisture.

Can be bought as a suit and or separates.

Checkout our base-layers and underscrubs on the back page.

Personalise your uniform with our in-house embroidery service.

[Click here for garment sizing](#)

Fit: Female

Fabric: 91% polyester
9% spandex



[Madison Top:](#)
[2525]
Mock-wrap V-neck fitted
Princess seams
2x hip pockets
1x hip insert phone pocket
1x hip insert pocket
Side vents

[Renee](#)
[Trousers/Pant:](#)
[9575]
Elasticated
drawstring waistband
Jogger leg
2x zip hip patch pockets
2x rear pockets
1x cargo pocket
Internal garment loop
Available in TALL
and SHORT fits by request

available sizes: (extra sizes by request)

XS S M L XL 2XL

available colours: (extra colours by request)

 Navy
 Pewter
 Black







HH Works
by Healing Hands.

Rhea jogger

AWB are delighted to offer Healing Hands as our premium range of scrubs. With the **HH Works** collection, you work all day long, so you need scrubs that can keep up. Made from a soft blend of four-way stretch polyester and spandex to be lightweight, breathable, durable, and stylish. This modern fit collection features soft, lightweight stretch fabric that promotes comfort and mobility while quickly wicks away moisture.

Can be bought as a suit and or separates.

Checkout our base-layers and underscrubs on the back page.

Personalise your uniform with our in-house embroidery service.

[Click here for garment sizing](#)

Fit: Female
Fabric: 91% polyester
9% spandex
Top: Currently not available

[Rhea Trousers/Pant:](#)
[050]
Hybrid rib knit
elasticated drawstring waistband
Jogger leg with rib knit cuff
2x zip hip pockets
1x insert zip hip pocket
2x rear pockets
2x cargo pockets with pen inserts
Internal garment loop
Available in TALL
and SHORT fits by request

available sizes: (extra sizes by request)

XS S M L XL 2XL

available colours: (extra colours by request)

 Navy
 Pewter
 Black



Top not currently available.

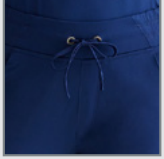



HH Works
by Healing Hands.

Maternity Mila top & Rose pant

AWB are delighted to offer Healing Hands as our premium range of scrubs. With the **HH Works** collection, you work all day long, so you need scrubs that can keep up. Made from a soft blend of four-way stretch polyester and spandex to be lightweight, breathable, durable, and stylish. This modern fit collection features soft, lightweight stretch fabric that promotes comfort and mobility while quickly wicks away moisture.

Can be bought as a suit and or separates.

Checkout our base-layers and underscrubs on the back page.

Personalise your uniform with our in-house embroidery service.

[Click here for garment sizing](#)

Fit: Female Maternity

Fabric: 91% polyester
9% spandex



Mila Top:
[2510]
V-neck maternity fit
2x hip pockets
Side stretch panels which grow with you and your baby.

Rose
Trousers/Pant:
[9510]
Rib knit soft elasticated over the bump waistband
Straight leg with vents
2x hip pockets
2x rear patch pockets
1x cargo pocket with pen & phone insert
Internal garment loop
Available in TALL and SHORT fits by request

available sizes: (extra sizes by request)

XS S M L XL 2XL

available colours: (extra colours by request)

 Navy
 Pewter
 Black



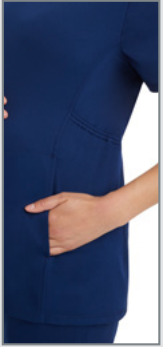



HH Works
by Healing Hands.

Mathew top & Ryan pant

AWB are delighted to offer Healing Hands as our premium range of scrubs. With the **HH Works** collection, you work all day long, so you need scrubs that can keep up. Made from a soft blend of four-way stretch polyester and spandex to be lightweight, breathable, durable, and stylish. This modern fit collection features soft, lightweight stretch fabric that promotes comfort and mobility while quickly wicks away moisture.

Can be bought as a suit and or separates.

Checkout our base-layers and underscrubs on the back page.

Personalise your uniform with our in-house embroidery service.

[Click here for garment sizing](#)

Fit: Male

Fabric: 91% polyester
9% spandex





[Mathew Top:](#) [2590]
V-neck modern fit
1x chest pocket w/pen insert
2x hip pockets w/pen inserts
1x hip insert phone pocket
1x hip insert pocket
Side vents

[Ryan Trousers/Pant:](#) [9590]
Hybrid elasticated drawstring waistband with button. Zip fly
Modern fit straight leg
2x hip pockets
2x rear velcro pockets
1x cargo pocket w/phone insert. Internal garment loop
Available in TALL and SHORT fits by request

available sizes: (extra sizes by request)

XS S M L XL 2XL

available colours: (extra colours by request)

 Navy
 Pewter
 Black
 Royal Blue
 Caribbean





Healing Hands Purple Label

AWB are delighted to offer Healing Hands as our premium range of scrubs.

Look Good, Feel Great. That's why the **Healing Hands Purple Label** scrubs were created. Made from a polyester-rayon-spandex stretch blend that promotes comfort and mobility, this innovative fabric creates a completely unique user experience that's designed to carry you through your workday with a luxurious 2-way stretch fabric.

The modern fabrics of Healing Hands provide freedom of movement, breathable, easy care and durable garments. Available in a range of colours enables tunic tops and trousers to be mixed and matched to create multiple aesthetic combinations. Can be bought as a suit and or separates.



AWB
always·wear·better



Model is
wearing
Pewter.



Journey top & Toby pant

AWB are delighted to offer Healing Hands as our premium range of scrubs. Look Good, Feel Great. That's why the **Healing Hands Purple Label** scrubs were created. Made from a polyester-rayon-spandex stretch blend that promotes comfort and mobility, this innovative fabric creates a completely unique user experience that's designed to carry you through your workday with a luxurious 2-way stretch fabric.

Can be bought as a suit and or separates.

Checkout our base-layers and underscrubs on the back page.

Personalise your uniform with our in-house embroidery service.

[Click here for garment sizing](#)

Fit: Female

Fabric: 77% polyester
20% rayon
9% spandex

Journey Top:
[2152]
Mandarin one button collar
2x hip pockets
Boxy fit
Sleeveless

Toby Trousers/Pant:
[9244]
Elasticated drawstring waistband
Jogger leg
2x zip hip pockets
2x rear pockets
2x cargo pockets
1x cargo zip pocket
Available in TALL and SHORT fits by request

available sizes: (extra sizes by request)

XS S M L XL 2XL

available colours: (extra colours by request)

 Navy
 Pewter
 Black



Tamara pant

AWB are delighted to offer Healing Hands as our premium range of scrubs. Look Good, Feel Great. That's why the **Healing Hands Purple Label** scrubs were created. Made from a polyester-rayon-spandex stretch blend that promotes comfort and mobility, this innovative fabric creates a completely unique user experience that's designed to carry you through your workday with a luxurious 2-way stretch fabric.

Can be bought as a suit and or separates.

Checkout our base-layers and underscrubs on the back page.

Personalise your uniform with our in-house embroidery service.

[Click here for garment sizing](#)

Fit: Female



Fabric: 77% polyester
20% rayon
9% spandex

Top: Currently not available

available sizes: (extra sizes by request)

XS S M L XL 2XL

available colours: (extra colours by request)

 Navy
 Pewter
 Black

[Tamara Trousers/Pant:](#)
[9181]

Elasticated
drawstring waistband
Standard leg vented
2x hip pockets
1x rear pocket
1x cargo pocket
1x cargo zip pocket
Pen insert
Available in TALL
and SHORT fits by request



Top not currently available.



Jake top & Dante pant

AWB are delighted to offer Healing Hands as our premium range of scrubs. Look Good, Feel Great. That's why the **Healing Hands Purple Label** scrubs were created. Made from a polyester-rayon-spandex stretch blend that promotes comfort and mobility, this innovative fabric creates a completely unique user experience that's designed to carry you through your workday with a luxurious 2-way stretch fabric.

Can be bought as a suit and or separates.

Checkout our base-layers and underscrubs on the back page.

Personalise your uniform with our in-house embroidery service.

[Click here for garment sizing](#)

Fit: Male

Fabric: 77% polyester
20% rayon
9% spandex

Jake Top: [2331]
V-neck modern fit
2x hip pockets
1x pen pocket insert
1x Chest pocket ID loop

available sizes: (extra sizes by request)

XS S M L XL 2XL

available colours: (extra colours by request)

 Navy
 Pewter
 Black

Dante
Trousers/Pant: [9301]
Knit elasticated drawstring waistband
Zip fly. ID Loop
Jogger leg with elasticated cuff
2x zip hip pockets
1x rear pocket
1x cargo pocket
Available in TALL and SHORT fits by request



Model is wearing Black.

Daniel pant

AWB are delighted to offer Healing Hands as our premium range of scrubs. Look Good, Feel Great. That's why the **Healing Hands Purple Label** scrubs were created. Made from a polyester-rayon-spandex stretch blend that promotes comfort and mobility, this innovative fabric creates a completely unique user experience that's designed to carry you through your workday with a luxurious 2-way stretch fabric.

Can be bought as a suit and or separates.

Checkout our base-layers and underscrubs on the back page.

Personalise your uniform with our in-house embroidery service.

[Click here for garment sizing](#)



Fit: Male
Fabric: 77% polyester
20% rayon
9% spandex
Top: Currently not available

[Daniel Trousers/Pant:](#)
[9300]
Elasticated drawstring waistband
Zip fly. ID Loop
Straight leg
2x hip pockets
1x rear pocket
2x cargo pockets (1x zip)
Available in TALL and SHORT fits by request

available sizes: (extra sizes by request)

XS S M L XL 2XL

available colours: (extra colours by request)

 Navy
 Pewter
 Black



Top not currently available.





Healing
Hands.

360

Healing Hands 360°

AWB are delighted to offer Healing Hands as our premium range of scrubs.

We are proud that the **Healing Hands 360** collection is made with recycled polyester fabric. The result is an easy care 4-way stretch fabric that's strong, wrinkle and fade resistant – and sustainable. When you wear our clothes, you'll be wearing something that was once part of a plastic bottle but now has been reborn into your new favourite piece of clothing.

This collection is our premium athleisure line.

The modern fabrics of Healing Hands provide freedom of movement, breathable, easy care and durable garments. Available in a range of colours enables tunic tops and trousers to be mixed and matched to create multiple aesthetic combinations. Can be bought as a suit and or separates.



AWB
always·wear·better



Model is
wearing
Pewter.



Healing
Hands.

360

Skyler top & Niko pant

AWB are delighted to offer Healing Hands as our premium range of scrubs. We are proud that the **Healing Hands 360** collection is made with recycled polyester fabric. The result is an easy care 4-way stretch fabric that's strong, wrinkle and fade resistant – and sustainable. When you wear our clothes, you'll be wearing something that was once part of a plastic bottle but now has been reborn into your new favourite piece of clothing. This collection is our premium athleisure line.

Can be bought as a suit and or separates.

Fit: Female

Fabric: 55% Recycled polyester
37% polyester
8% spandex

[Skyler Top:](#)
[32285]

V-neck modern athletic
2x hip pockets
Side vents

[Niko](#)
[Trousers/Pant:](#)
[39157]

Modern athletic fit
Elasticated waistband
Tapered standard leg
2x zip hip pockets
2x cargo pockets on one side

Checkout our base-layers and underscrubs on the back page.



Personalise your uniform with our in-house embroidery service.

[Click here for garment sizing](#)

available sizes: (extra sizes by request)

XS S M L XL 2XL

available colours: (extra colours by request)

 Navy
 Pewter
 Black

additional colours available on Skyler only

 Wine
 Mid Blue/Ciel
 Royal Blue







Healing
Hands.

360

Sonia top & Nisha pant

AWB are delighted to offer Healing Hands as our premium range of scrubs. We are proud that the **Healing Hands 360** collection is made with recycled polyester fabric. The result is an easy care 4-way stretch fabric that's strong, wrinkle and fade resistant – and sustainable. When you wear our clothes, you'll be wearing something that was once part of a plastic bottle but now has been reborn into your new favourite piece of clothing. This collection is our premium athleisure line.

Can be bought as a suit and or separates.

Fit: Female

Fabric: 55% Recycled polyester
37% polyester
8% spandex

[Sonia Top:](#)
[32274]

Y-neck modern
Reflective stripe
2x hip pockets
with pen section
1x insert pocket
Side vents

[Nisha](#)
[Trousers/Pant:](#)
[39152]

Modern fit Rib-knit hybrid
Elasticated drawstring
waistband
Standard vented leg
2x zip hip pockets (1x insert)
2x rear pockets
1x cargo pocket

Checkout our
base-layers and
underscrubs on
the back page.

Personalise your
uniform with
our in-house
embroidery
service.

[Click here for
garment sizing](#)

available sizes: (extra sizes by request)

XS S M L XL 2XL

available colours: (extra colours by request)

 Navy

 Pewter

 Black

 Wine

 Mid Blue/Ciel

 Royal Blue





Model is wearing Wine.



Healing
Hands.

360

Sandy top & Naya pant

AWB are delighted to offer Healing Hands as our premium range of scrubs. We are proud that the **Healing Hands 360** collection is made with recycled polyester fabric. The result is an easy care 4-way stretch fabric that's strong, wrinkle and fade resistant – and sustainable. When you wear our clothes, you'll be wearing something that was once part of a plastic bottle but now has been reborn into your new favourite piece of clothing. This collection is our premium athleisure line.

Can be bought as a suit and or separates.

Fit: Female Modern Athletic

Fabric: 55% Recycled polyester
37% polyester
8% spandex

[Sandy Top:](#)
[32286]

Mandarin collar
Boxy zip top comfy fit
2x hip insert pockets
Side vents

[Naya](#)
[Trousers/Pant:](#)
[39156]

Elasticated
drawstring waistband
Jogger leg with knit cuff
2x zip hip pockets
2x rear pockets
1x cargo pocket
1x zip cargo pocket

Checkout our
base-layers and
underscrubs on
the back page.

Personalise your
uniform with
our in-house
embroidery
service.

[Click here for
garment sizing](#)

available sizes: (extra sizes by request)

XS S M L XL 2XL

available colours: (extra colours by request)

 Navy
 Pewter
 Black







Healing
Hands.

360

Spencer top & Nolen pant

AWB are delighted to offer Healing Hands as our premium range of scrubs. We are proud that the **Healing Hands 360** collection is made with recycled polyester fabric. The result is an easy care 4-way stretch fabric that's strong, wrinkle and fade resistant – and sustainable. When you wear our clothes, you'll be wearing something that was once part of a plastic bottle but now has been reborn into your new favourite piece of clothing. This collection is our premium athleisure line.

Can be bought as a suit and or separates.

Fit: Male Modern

Fabric: 55% Recycled polyester
37% polyester
8% spandex

[Spencer Top:](#) [32381] V-neck modern athletic
1x chest pocket with pen insert
Side vents

[Nolen Trousers/Pant:](#) [39172] Elasticated drawstring waistband. Zip fly
Jogger leg with knit cuff
2x hip pockets
2x rear pockets
1x cargo pocket
1x zip cargo pocket

Checkout our base-layers and underscrubs on the back page.

Personalise your uniform with our in-house embroidery service.

[Click here for garment sizing](#)

available sizes: (extra sizes by request)

XS S M L XL 2XL

available colours: (extra colours by request)

 Navy
 Pewter
 Black







Healing
Hands.

360

Steven top & Noah pant

AWB are delighted to offer Healing Hands as our premium range of scrubs. We are proud that the **Healing Hands 360** collection is made with recycled polyester fabric. The result is an easy care 4-way stretch fabric that's strong, wrinkle and fade resistant – and sustainable. When you wear our clothes, you'll be wearing something that was once part of a plastic bottle but now has been reborn into your new favourite piece of clothing. This collection is our premium athleisure line.

Can be bought as a suit and or separates.

Fit: Male Modern

Fabric: 55% Recycled polyester
37% polyester
8% spandex

[Steven Top:](#)
[32382]

V-neck
2x hip pockets
1x chest pocket
with pen insert
Side vents

[Noah](#)
[Trousers/Pant:](#)
[39173]

Elasticated drawstring
waistband. Zip fly
Straight standard leg
2x hip pockets
2x rear pockets
1x cargo pocket with pen insert
1x zip cargo pocket
Available in SHORT fits by
request

Checkout our
base-layers and
underscrubs on
the back page.

Personalise your
uniform with
our in-house
embroidery
service.

[Click here for
garment sizing](#)

available sizes: (extra sizes by request)

XS S M L XL 2XL

available colours: (extra colours by request)

 Navy
 Pewter
 Black
 Wine
 Mid Blue/Ciel
 Royal Blue



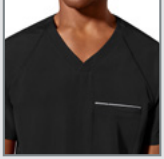



Healing
Hands.

360

Carly jacket

AWB are delighted to offer Healing Hands as our premium range of scrubs. We are proud that the **Healing Hands 360** collection is made with recycled polyester fabric. The result is an easy care 4-way stretch fabric that's strong, wrinkle and fade resistant – and sustainable. When you wear our clothes, you'll be wearing something that was once part of a plastic bottle but now has been reborn into your new favourite piece of clothing. This collection is our premium athleisure line.

Can be bought as a suit and or separates.

Fit: Female

Fabric: 55% Recycled polyester
37% polyester
8% spandex

[Carly Jacket:](#) Zip front with reflective accents for advisability
[35068] 2x zip hip pockets
2x internal pockets
1x internal phone pocket
Knit cuffs

Checkout our base-layers and underscrubs on the back page.

Personalise your uniform with our in-house embroidery service.

[Click here for garment sizing](#)

available sizes: (extra sizes by request)

XS S M L XL 2XL

available colours:

 Navy
 Black





Model is wearing Naya trouser.



Healing
Hands.

360

Samuel jacket

AWB are delighted to offer Healing Hands as our premium range of scrubs. We are proud that the **Healing Hands 360** collection is made with recycled polyester fabric. The result is an easy care 4-way stretch fabric that's strong, wrinkle and fade resistant – and sustainable. When you wear our clothes, you'll be wearing something that was once part of a plastic bottle but now has been reborn into your new favourite piece of clothing. This collection is our premium athleisure line.

Can be bought as a suit and or separates.

Fit: Male
Fabric: 55% Recycled polyester
37% polyester
8% spandex

[Samuel Jacket:](#)
[35350]
Bomber jacket style with elasticated base
Zip front with reflective accents for visibility
2x zip hip pockets
2x internal pockets
1x internal phone pocket
1x internal pen pocket
Knit cuffs

Checkout our base-layers and underscrubs on the back page.



Personalise your uniform with our in-house embroidery service.

[Click here for garment sizing](#)

available sizes: (extra sizes by request)

XS S M L XL 2XL

available colours:

 Navy
 Black





Model is wearing Nolen trouser.

Garment sizing





Please note garment is generously sized for ease of movement

	X Small	Small	Medium	Large	X Large	2X Large	3X Large	Tol. +/-
A. Neck Width	165 [6.5]	184 [7.25]	184 [7.25]	191 [7.5]	197 [7.75]	197 [7.75]	197 [7.75]	10 [0.5]
B. Neck Opening	559 [22]	584 [23]	584 [23]	635 [25]	635 [25]	648 [25.5]	648 [25.5]	10 [0.5]
C. Sleeve Length	305 [12]	330 [13]	368 [14.5]	381 [15]	394 [15.5]	406 [16]	432 [17]	10 [0.5]
D. Sleeve Opening	432 [17]	457 [18]	457 [18]	483 [19]	483 [19]	508 [20]	508 [20]	10 [0.5]
E. Chest/Bust	1016 [40]	1118 [44]	1219 [48]	1320 [52]	1422 [56]	1473 [58]	1575 [62]	25 [1]
F. Back Length	686 [27]	686 [27]	724 [28.5]	724 [28.5]	724 [28.5]	762 [30]	813 [32]	10 [0.5]
G. Sleeve Inseam	152 [6]	152 [6]	152 [6]	159 [6.25]	159 [6.25]	159 [6.25]	159 [6.25]	10 [0.5]
H. Sweep	1067 [42]	1105 [43.5]	1194 [47]	1321 [52]	1448 [57]	1511 [59.5]	1562 [61.5]	10 [0.5]
J. Lower Pocket Location	95 [3.75]	95 [3.75]	95 [3.75]	95 [3.75]	95 [3.75]	95 [3.75]	95 [3.75]	
K. Lower Pocket Size (LxW)	171 x 152 [6.75 x 6]	171 x 152 [6.75 x 6]	171 x 152 [6.75 x 6]	171 x 152 [6.75 x 6]	178 x 159 [7 x 6.25]	178 x 159 [7 x 6.25]	197 x 159 [7.75 x 6.25]	
Neck Twill Tape Colour	Blue	Yellow	Brown	White	Pink	Orange	Red	

Front

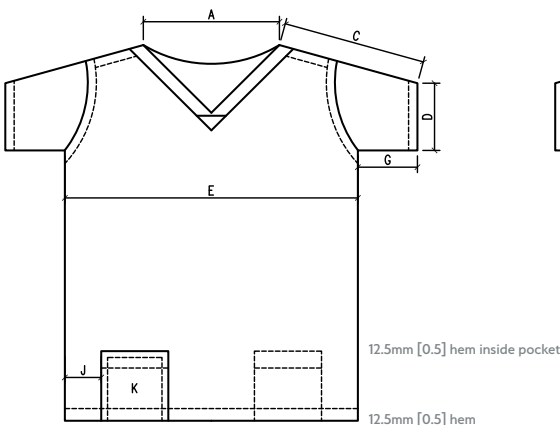

Back

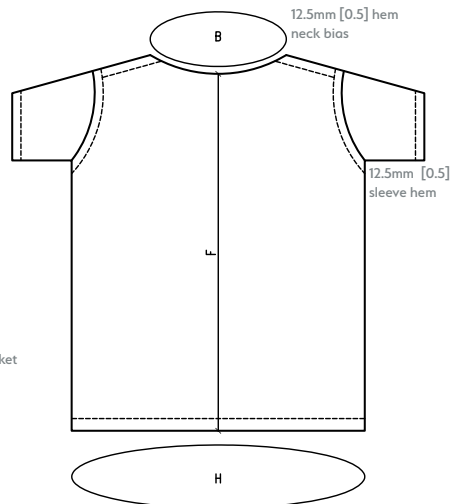

All dimensions in millimetres [inches in brackets].
Drawing not to scale. Dimensions are approximate.

Please note garment is generously sized for ease of movement

	X Small	Small	Medium	Large	X Large	2X Large	3X Large	Tol. +/-
A. Waist	940 [37]	1016 [40]	1092 [43]	1168 [46]	1245 [49]	1321 [52]	1422 [56]	25 [1]
B. Front Rise	368 [14.5]	381 [15]	400 [15.75]	400 [15.75]	406 [16]	406 [16]	419 [16.5]	25 [1]
C. Back Rise	394 [15.5]	406 [16]	406 [16]	419 [16.5]	419 [16.5]	432 [17]	445 [17.5]	10 [0.5]
D. Inseam	711 [28]	711 [28]	724 [28.5]	737 [29]	737 [29]	762 [30]	813 [32]	10 [0.5]
E. Side Length	1067 [42]	1067 [42]	1105 [43.5]	1105 [43.5]	1118 [44]	1143 [45]	1168 [46]	10 [0.5]
F. Leg Opening	432 [17]	457 [18]	470 [18.5]	489 [19.25]	521 [20.5]	552 [21.75]	584 [23]	25 [1]
G. Hips 203mm (8") below waist	483 [19]	546 [21.5]	565 [22.25]	610 [24]	648 [25.5]	724 [28.5]	762 [30]	25 [1]
H. Pocket Size	165 x 178 [6.5 x 7]	165 x 178 [6.5 x 7]	165 x 178 [6.5 x 7]	165 x 178 [6.5 x 7]	165 x 178 [6.5 x 7]	165 x 178 [6.5 x 7]	165 x 178 [6.5 x 7]	25 [1]
J. Tie Length	1524 [60]	1600 [63]	1676 [66]	1753 [69]	1930 [76]	2083 [82]	2255 [88]	
Twill Tape Colour	Blue	Yellow	Brown	White	Pink	Orange	Red	

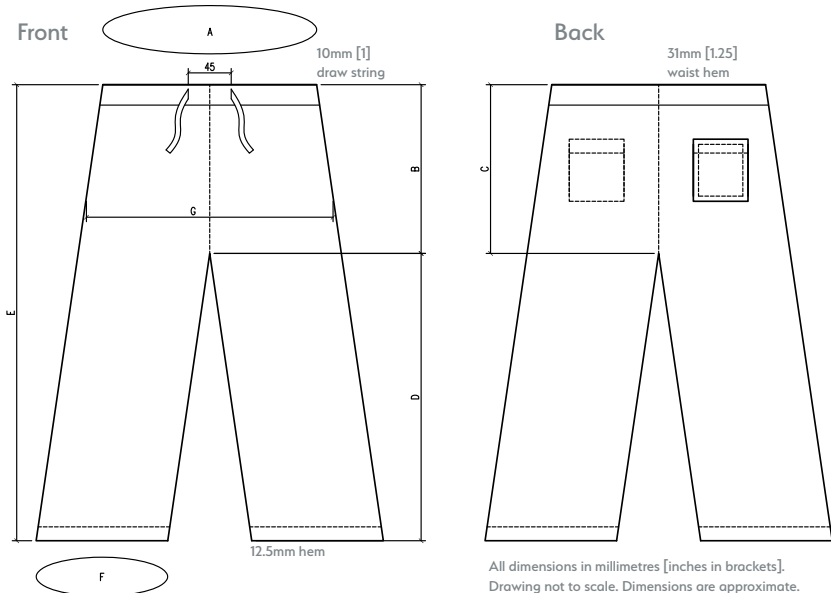

1st Choice Warm-up jacket garment size

Please note garment is generously sized for ease of movement

	Small	Medium	Large	X Large	2X Large	3X Large	Tol. +/-
A. Neck Width	140 [5.5]	140 [5.5]	146 [5.75]	146 [5.75]	156 [6]	222 [8.75]	10 [1]
B. Neck Opening	395 [15.5]	420 [16.5]	430 [17]	445 [17.5]	445 [17.5]	585 [23]	25 [1]
C. Not used	N/A	N/A	N/A	N/A	N/A	N/A	N/A
D. Not used	N/A	N/A </td <td>N/A</td> <td>N/A</td> <td>N/A</td> <td>N/A</td> <td>N/A</td>	N/A	N/A	N/A	N/A	N/A
E. Chest/Bust	585 [23]	622 [24.5]	648 [25.5]	718 [28.25]	768 [30.25]	845 [33.25]	25 [1]
F. Back Length	794 [31.25]	800 [31.5]	800 [31.5]	800 [31.5]	800 [31.5]	832 [32.75]	25 [1]
G. Sleeve Inseam	483 [19]	483 [19]	495 [19.5]	510 [20]	510 [20]	510 [20]	25 [1]
H. Sweep	1270 [50]	1359 [53.5]	1397 [55]	1537 [60.5]	1664 [65.5]	1772 [69.75]	25 [1]
J. Sleeve Opening	279 [11]	286 [11.25]	292 [11.5]	292 [11.5]	310 [12]	335 [13]	25 [1]
K. Lower Pocket Size (LxW)	180 x 171 [7 x 6.75]	180 x 171 [7 x 6.75]	180 x 171 [7 x 6.75]	180 x 171 [7 x 6.75]	180 x 171 [7 x 6.75]	180 x 171 [7 x 6.75]	
Twill Tape Colour	Yellow	Brown	White	Pink	Orange	Red	

Front

Back

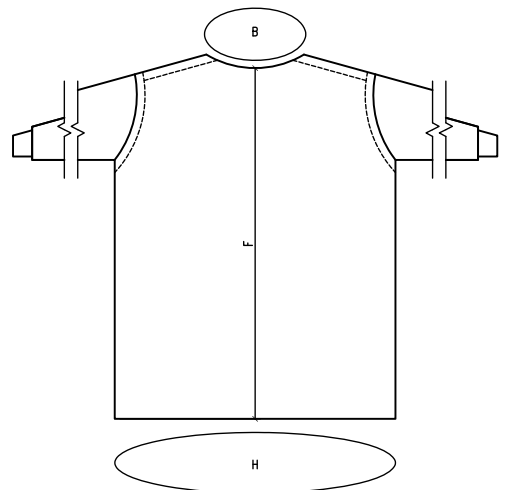
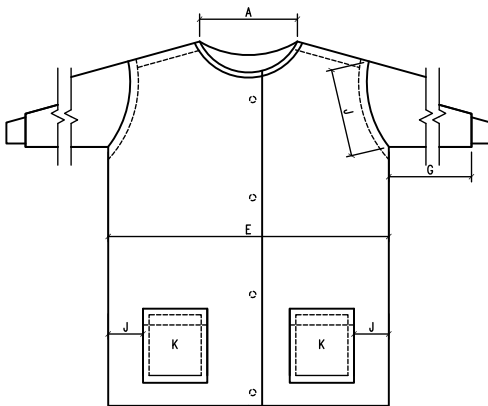

All dimensions in millimetres [inches in brackets].
Drawing not to scale. Dimensions are approximate.



Models are
wearing
Mid Green.
Models are
wearing
under-scrubs.

1st Choice Patient Gown

garment size

	Standard Blue Diamond	Bariatric Green Diamond	Tol. +/-
A. Not Used	N/A	N/A	12.5 [0.5]
B. Neck Opening	710 [28]	1100 [43.25]	12.5 [0.5]
C. Sleeve Length	465 [18.25]	520 [20.5]	12.5 [0.5]
D. Sleeve Opening	255 [10]	360 [14]	12.5 [0.5]
E. Chest	710 [30]	1050 [41.25]	12.5 [0.5]
F. Back Length	1220 [48]	1310 [51.5]	12.5 [0.5]
G. Sleeve Inseam	205 [8]	185 [7.25]	12.5 [0.5]
H. Sweep	1610 [63.5]	2220 [87.5]	12.5 [0.5]

Front

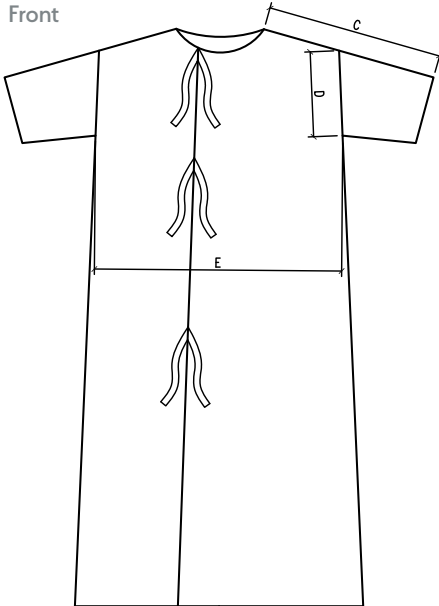

Back

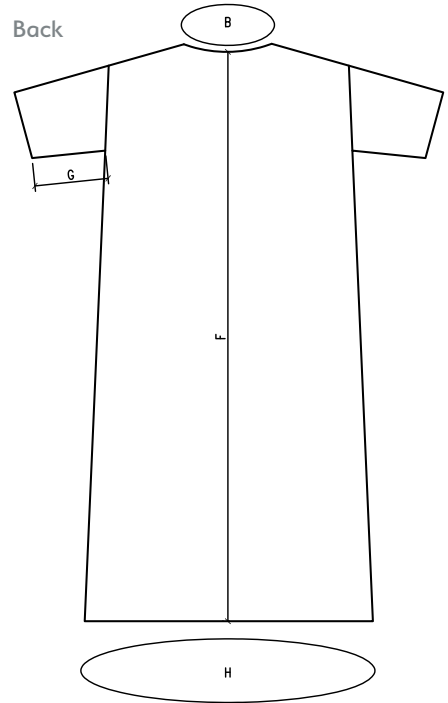

All dimensions in millimetres [inches in brackets].
Drawing not to scale. Dimensions are approximate.

1st Choice Patient Robe

garment size

	Standard Blue Diamond	Tol. +/-
A. Not Used	N/A	25 [1]
B. Neck Opening	410 min [16]	25 [1]
C. Sleeve Length	650 [25.5]	25 [1]
D. Sleeve Opening	250 [9.75]	25 [1]
E. Chest	640 [25.25]	25 [1]
F. Back Length	1100 [43.25]	25 [1]
G. Sleeve Inseam	345 [13.5]	25 [1]
H. Sweep	1543 [60.75]	25 [1]

Front

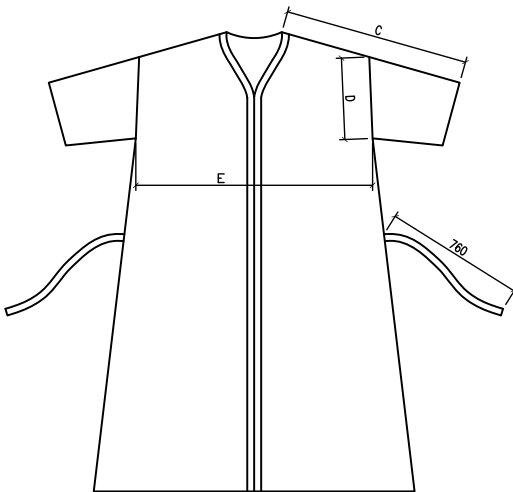

Back

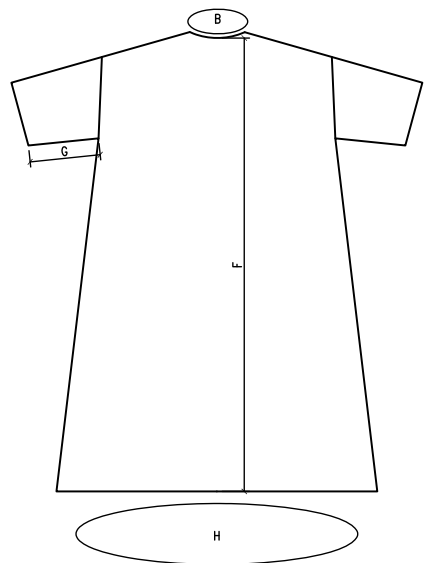

All dimensions in millimetres [inches in brackets].
Drawing not to scale. Dimensions are approximate.

Tunic Top - please note garment is generously sized for ease of movement

	X Small	Small	Medium	Large	X Large	2X Large	3X Large	Tol. +/-
A. Neck Width	165 [6.5]	184 [7.25]	184 [7.25]	191 [7.5]	197 [7.75]	197 [7.75]	197 [7.75]	10 [0.5]
B. Neck Opening	559 [22]	584 [23]	584 [23]	635 [25]	635 [25]	648 [25.5]	648 [25.5]	10 [0.5]
C. Sleeve Length	305 [12]	330 [13]	368 [14.5]	381 [15]	394 [15.5]	406 [16]	432 [17]	10 [0.5]
D. Sleeve Opening	432 [17]	457 [18]	457 [18]	483 [19]	483 [19]	508 [20]	508 [20]	10 [0.5]
E. Chest/Bust	1016 [40]	1118 [44]	1219 [48]	1320 [52]	1422 [56]	1473 [58]	1575 [62]	25 [1]
F. Back Length	686 [27]	686 [27]	724 [28.5]	724 [28.5]	724 [28.5]	762 [30]	813 [32]	10 [0.5]
G. Sleeve Inseam	152 [6]	152 [6]	152 [6]	159 [6.25]	159 [6.25]	159 [6.25]	159 [6.25]	10 [0.5]
H. Sweep	1067 [42]	1105 [43.5]	1194 [47]	1321 [52]	1448 [57]	1511 [59.5]	1562 [61.5]	10 [0.5]
J. Lower Pocket Location	95 [3.75]	95 [3.75]	95 [3.75]	95 [3.75]	95 [3.75]	95 [3.75]	95 [3.75]	
K. Lower Pocket Size (LxW)	171 x 152 [6.75 x 6]	171 x 152 [6.75 x 6]	171 x 152 [6.75 x 6]	171 x 152 [6.75 x 6]	178 x 159 [7 x 6.25]	178 x 159 [7 x 6.25]	197 x 159 [7.75 x 6.25]	
Neck stamp colour Colour	Blue	Yellow	Brown	White	Pink	Orange	Red	

Front

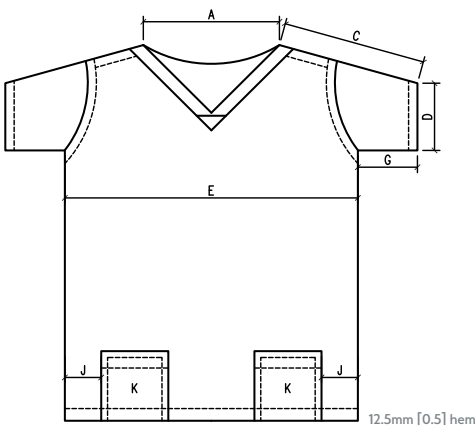

Back

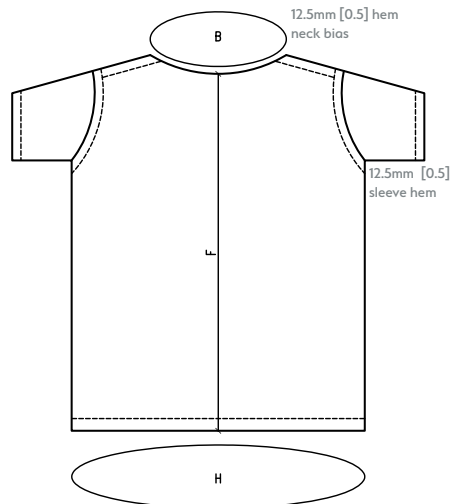

All dimensions in millimetres [inches in brackets].
Drawing not to scale. Dimensions are approximate.

Trousers - please note garment is generously sized for ease of movement

TALL Trousers INSEAM (D) = 850 [33.5] SHORT Trousers INSEAM (D) = 700 [27.5]

	X Small	Small	Medium	Large	X Large	2X Large	3X Large	Tol. +/-
A. Waist	940 [37]	1016 [40]	1092 [43]	1168 [46]	1245 [49]	1321 [52]	1422 [56]	25 [1]
B. Front Rise	368 [14.5]	381 [15]	400 [15.75]	400 [15.75]	406 [16]	406 [16]	419 [16.5]	25 [1]
C. Back Rise	394 [15.5]	406 [16]	406 [16]	419 [16.5]	419 [16.5]	432 [17]	445 [17.5]	10 [0.5]
D. Inseam	711 [28]	711 [28]	724 [28.5]	737 [29]	737 [29]	762 [30]	815 [32]	10 [0.5]
E. Side Length	1067 [42]	1067 [42]	1105 [43.5]	1105 [43.5]	1118 [44]	1143 [45]	1168 [46]	10 [0.5]
F. Leg Opening	432 [17]	457 [18]	470 [18.5]	489 [19.25]	521 [20.5]	552 [21.75]	584 [23]	25 [1]
G. Hips 203mm (8") below waist	483 [19]	546 [21.5]	565 [22.25]	610 [24]	648 [25.5]	724 [28.5]	762 [30]	25 [1]
H. Pocket Size	165 x 178 [6.5 x 7]	165 x 178 [6.5 x 7]	165 x 178 [6.5 x 7]	165 x 178 [6.5 x 7]	165 x 178 [6.5 x 7]	165 x 178 [6.5 x 7]	165 x 178 [6.5 x 7]	25 [1]
J. Tie Length	1524 [60]	1600 [63]	1676 [66]	1753 [69]	1930 [76]	2083 [82]	2255 [88]	
K. Cargo Pocket Size	188 x 200 [7.5 x 8]	188 x 200 [7.5 x 8]	188 x 200 [7.5 x 8]	188 x 200 [7.5 x 8]	188 x 200 [7.5 x 8]	188 x 200 [7.5 x 8]	188 x 200 [7.5 x 8]	
Drawstring Colour	As garment	As garment	As garment	As garment	As garment	As garment	As garment	

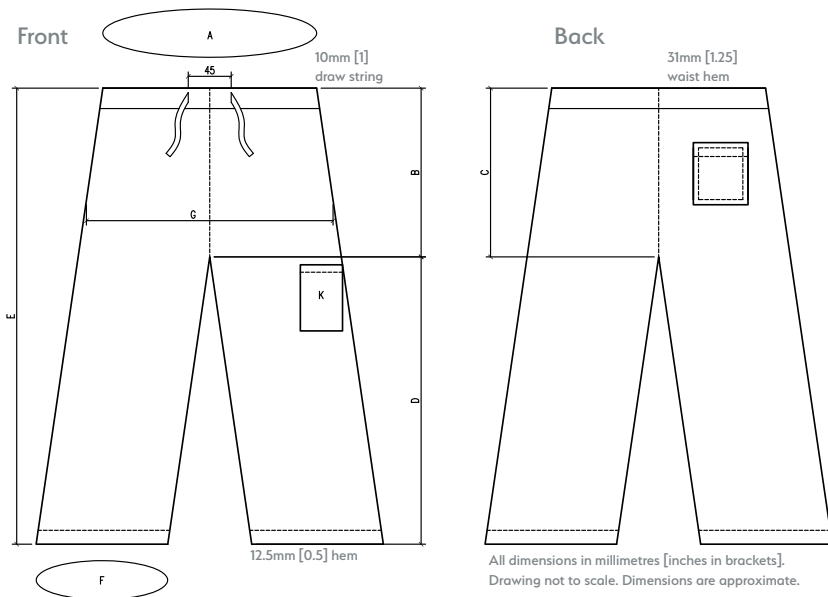

Originals & Maternity sizing

If one of your measurements is between two sizes, order the smaller size for a tighter fit or the larger size for a looser fit. If your measurements for hips and waist correspond to two different suggested sizes, order the one indicated by your hip measurement.

Unisex Traditional Fit

	X Small	Small	Medium	Large	X Large	2X Large	3X Large	Tol. +/-
A. Chest/Bust	889 - 940 [35 - 37]	965 - 1016 [38 - 40]	1041 - 1092 [41 - 43]	1118 - 1194 [44 - 47]	1219 - 1295 [48 - 51]	1321 - 1397 [52 - 55]	1422 - 1499 [56 - 59]	10 [0.5]
B. Waist	711 - 762 [28 - 30]	787 - 838 [31 - 33]	864 - 914 [34 - 36]	940 - 1016 [37 - 40]	1041 - 1118 [41 - 44]	1145 - 1219 [45 - 48]	1245 - 1321 [49 - 52]	10 [0.5]
C. Hips	889 - 940 [35 - 37]	965 - 1016 [38 - 40]	1041 - 1092 [41 - 43]	1118 - 1194 [44 - 47]	1219 - 1295 [48 - 51]	1321 - 1397 [52 - 55]	1422 - 1499 [56 - 59]	10 [0.5]
Trousers/Pant: In-seam: Regular 787 - 813 [31 - 32], Short 737 - 762 [29 - 30], Tall 864 - 889 [34 - 35] All dimensions are in millimetres [inches in brackets]								

Female Traditional/Maternity Fit

	X Small	Small	Medium	Large	X Large	2X Large	3X Large	Tol. +/-
A. Chest	889 - 940 [35 - 37]	965 - 991 [38 - 39]	1016 - 1067 [40 - 42]	1092 - 1143 [43 - 45]	1168 - 1219 [46 - 48]	1245 - 1321 [49 - 52]	1346 - 1422 [53 - 56]	10 [0.5]
B. Waist	686 - 711 [27 - 28]	737 - 762 [29 - 30]	787 - 838 [31 - 33]	864 - 914 [34 - 36]	940 - 991 [37 - 39]	1016 - 1092 [40 - 45]	1118 - 1194 [44 - 47]	10 [0.5]
C. Hips	889 - 940 [35 - 37]	965 - 991 [38 - 39]	1016 - 1067 [40 - 42]	1092 - 1143 [43 - 45]	1168 - 1219 [46 - 48]	1245 - 1321 [49 - 52]	1346 - 1422 [53 - 56]	10 [0.5]
Trousers/Pant: In-seam: Regular 762 - 787 [30 - 31], Short 699 - 724 [27.5 - 28.5], Tall 838 - 864 [33 - 34] All dimensions are in millimetres [inches in brackets]								

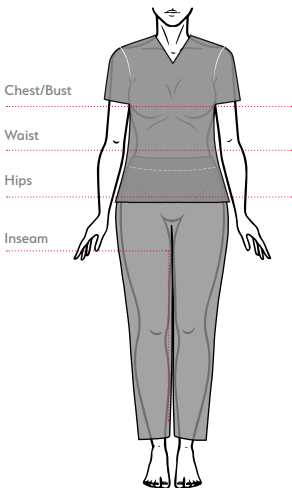

Chest/Bust Measure under the arms around the fullest part of the bust/ chest.

Waist Measure under the natural waistline, loosely holding the tape measure.

Hips Measure around the fullest part of the hips.

Inseam Measure along the inside of the leg, from just below the crotch to 254mm below the ankle

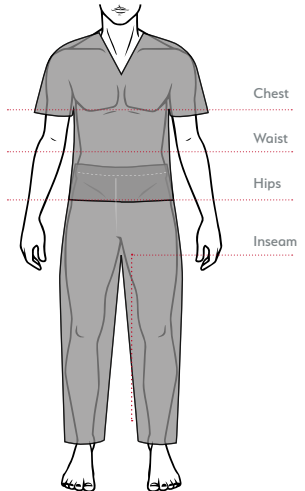



Model is
wearing
Pewter.



Galaxy scrubs garment sizes

Tunic Top - please note garment is generously sized for ease of movement

	X Small	Small	Medium	Large	X Large	2X Large	3X Large	Tol. +/-
A. Neck Width	170 [7]	184 [7.25]	190 [7.5]	196 [7.75]	202 [8]	208 [8.25]	214 [8.5]	5 [0.25]
B. Neck Opening	480 [19]	490 [19.25]	500 [19.5]	510 [20]	520 [20.5]	530 [20.75]	540 [21.25]	25 [1]
C. Sleeve Length	170 [7]	184 [7.25]	190 [7.5]	196 [7.75]	210 [8.25]	220 [8.5]	230 [9]	10 [0.5]
D. Sleeve Opening	184 [7.25]	190 [7.5]	200 [7.75]	210 [8.25]	220 [8.5]	230 [9]	240 [9.5]	10 [0.5]
E. Chest/Bust	787 - 864 [31 - 34]	889 - 940 [35 - 37]	965 - 1016 [38 - 40]	1041 - 1118 [41 - 44]	1143 - 1219 [45 - 48]	1245 - 1321 [49 - 52]	1346 - 1422 [53 - 56]	25 [1]
F. Back Length	692 [27.25]	711 [28]	730 [28.75]	749 [29.5]	768 [30.25]	787 [31]	813 [32]	25 [1]
G. Front Neck drop from Collar back	140 [5.5]	146 [5.75]	152 [6]	152 [6]	159 [6.25]	165 [6.5]	171 [6.75]	5 [0.25]
H. Sweep	1016 [40]	1016 [40]	1181 [46.5]	1238 [48.75]	1291 [50.75]	1384 [54.5]	1422 [56]	25 [1]
J. O/A Sleeve length	480 [19]	502 [19.75]	521 [20.5]	540 [21.25]	559 [22]	578 [22.75]	597 [23.5]	5 [0.25]
K. Lower Pocket Size (LxW)	197 x 191 [7.75 x 7.5]	197 x 191 [7.75 x 7.5]	197 x 191 [7.75 x 7.5]	222 x 210 [8.75 x 8.25]	222 x 210 [8.75 x 8.25]	222 x 210 [8.75 x 8.25]	222 x 210 [8.75 x 8.25]	
Neck stamp colour Colour	N/A	N/A	N/A	N/A	N/A	N/A	N/A	

Front

Back

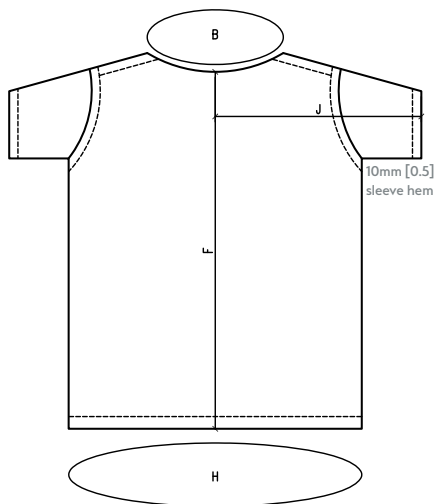
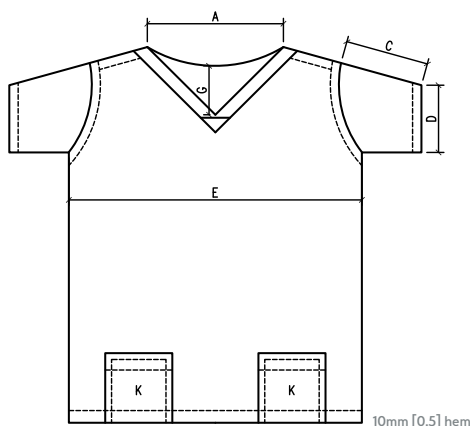

All dimensions in millimetres [inches in brackets].
Drawing not to scale. Dimensions are approximate.



Trousers - please note garment is generously sized for ease of movement

TALL Trousers INSEAM (D) = 850 [33.5] SHORT Trousers INSEAM (D) = 700 [27.5]

	X Small	Small	Medium	Large	X Large	2X Large	3X Large	Tol. +/-
A. Waist	610 - 686 [24 - 27]	711 - 762 [28 - 30]	787 - 864 [31 - 34]	889 - 965 [35 - 38]	991 - 1067 [39 - 42]	1092 - 1168 [43 - 46]	1194 - 1270 [47 - 50]	25 [1]
B. Front Rise	292 [11.5]	305 [12]	311 [12.25]	318 [12.5]	331 [13]	343 [13.5]	349 [13.75]	10 [0.5]
C. Back Rise	387 [15.25]	406 [16]	419 [16.5]	432 [17]	445 [17.5]	457 [18]	470 [18.5]	10 [0.5]
D. Inseam	787 [31]	787 [31]	787 [31]	787 [31]	787 [31]	787 [31]	787 [31]	10 [0.5]
E. Side Length	1073 [42.25]	1073 [42.25]	1073 [42.25]	1073 [42.25]	1073 [42.25]	1073 [42.25]	1073 [42.25]	25 [1]
F. Leg Opening	419 [16.5]	438 [17.25]	457 [18]	483 [19]	495 [19.5]	521 [20.5]	540 [21.25]	25 [1]
G. Hips 203mm (8") below waist	813 - 889 [32 - 35]	914 - 965 [36 - 38]	991 - 1014 [39 - 41]	1067 - 1118 [42 - 44]	1143 - 1219 [45 - 48]	1245 - 1321 [49 - 52]	1346 - 1422 [53 - 56]	25 [1]
H. Pocket Size	145 x 145 [5.75 x 5.75]	145 x 145 [5.75 x 5.75]	145 x 145 [5.75 x 5.75]	145 x 145 [5.75 x 5.75]	145 x 145 [5.75 x 5.75]	145 x 145 [5.75 x 5.75]	145 x 145 [5.75 x 5.75]	
J. Hip Pocket Opening	175 [6.75]	175 [6.75]	175 [6.75]	180 [7]	180 [7]	180 [7]	180 [7]	10 [0.5]
K. Cargo Pocket Size (LxW)	200 x 200 [8 x 8]	200 x 200 [8 x 8]	200 x 200 [8 x 8]	200 x 200 [8 x 8]	210 x 210 [8.25 x 8.25]	210 x 210 [8.25 x 8.25]	210 x 210 [8.25 x 8.25]	
Twill Tape Colour	As garment	As garment	As garment	As garment	As garment	As garment	As garment	

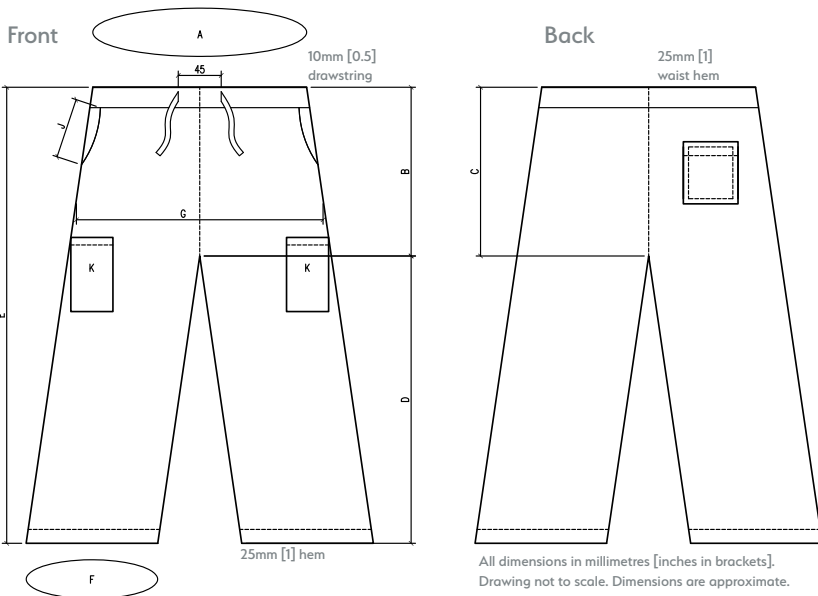



Galaxy Mock-wrap top garment sizes

	X Small	Small	Medium	Large	X Large	2X Large	3X Large	Tol. +/-
A. Neck Width	178 [7]	184 [7.25]	184 [7.25]	190 [7.5]	196 [7.75]	202 [8]	208 [8.25]	5 [0.25]
B. Neck Opening	480 [19]	490 [19.25]	500 [19.5]	510 [20]	520 [20.5]	530 [20.75]	540 [21.25]	25 [1]
C. Sleeve Length	394 [15.5]	406 [16]	419 [16.5]	445 [17.5]	470 [18.5]	495 [19.5]	521 [20.5]	5 [0.25]
D. Sleeve Opening	171 [6.75]	184 [7.25]	190 [7.5]	202 [8]	208 [8.25]	222 [8.75]	229 [9]	10 [0.5]
E. Chest/Bust	508 [20]	533 [21]	559 [22]	597 [23.5]	635 [25]	660 [26]	699 [27.5]	25 [1]
F. Back Length	686 [27]	711 [28]	730 [28.75]	749 [29.5]	768 [30.25]	787 [31]	813 [32]	25 [1]
G. Front Neck drop from Collar back	165 [6.5]	171 [6.75]	178 [7]	178 [7]	184 [7.25]	191 [7.5]	197 [7.75]	10 [0.5]
H. Sweep	1080 [42.5]	1143 [45]	1181 [46.5]	1257 [49.5]	1340 [52.75]	1391 [54.75]	1480 [58.25]	25 [1]
J. O/A Sleeve length	394 [15.5]	406 [16]	419 [16.5]	445 [17.5]	470 [18.5]	495 [19.5]	521 [20.5]	5 [0.25]
K. Lower Pocket Size (LxW)	178 x 210 [7 x 8.25]	178 x 210 [7 x 8.25]	178 x 210 [7 x 8.25]	184 x 222 [7.25 x 8.75]	184 x 222 [7.25 x 8.75]	184 x 222 [7.25 x 8.75]	184 x 222 [7.25 x 8.75]	

Front

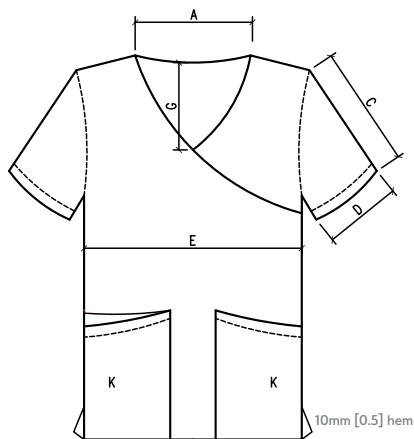

Back

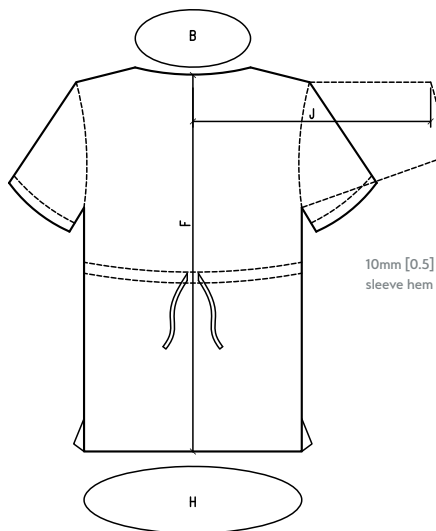

All dimensions in millimetres [inches in brackets].
Drawing not to scale. Dimensions are approximate.





Model is wearing
Shocking Pink.
Model is wearing
under-scrubs.



Galaxy Healthcare Tunic garment sizes

	8	10	12	14	16	18	20	22	24	26	28	30	32	Tol +/-
A. Not Used	N/A	N/A	N/A	N/A	N/A	N/A	N/A	N/A	N/A	N/A	N/A	N/A	N/A	N/A
B. Not Used	N/A	N/A	N/A	N/A	N/A	N/A	N/A	N/A	N/A	N/A	N/A	N/A	N/A	N/A
C. Sleeve Length	254 [10]	254 [10]	260 [10.25]	267 [10.5]	267 [10.5]	273 [10.75]	273 [10.75]	279 [11]	286 [11.25]	286 [11.25]	292 [11.5]	292 [11.5]	305 [12]	5 [0.25]
D. Sleeve Opening	152 [6]	159 [6.25]	165 [6.5]	178 [7]	191 [7.5]	197 [7.75]	210 [8.25]	222 [8.75]	235 [9.25]	248 [9.75]	260 [10.25]	273 [10.75]	286 [11.25]	5 [0.25]
E. Chest/Bust	451 [17.75]	470 [18.5]	489 [19.25]	508 [20]	533 [21]	565 [22.25]	597 [23.5]	622 [24.5]	654 [25.75]	686 [27]	711 [28]	743 [29.25]	775 [30.5]	10 [0.5]
F. Back Length	749 [29.5]	756 [29.75]	762 [30]	762 [30]	768 [30.25]	775 [30.5]	781 [30.75]	787 [31]	787 [31]	794 [31.25]	800 [31.5]	806 [31.75]	810 [32]	10 [0.5]
G. Waist	419 [16.5]	425 [16.75]	445 [17.5]	464 [18.25]	495 [19.5]	521 [20.5]	553 [21.75]	584 [23]	610 [24]	641 [25.25]	673 [26.5]	705 [27.75]	737 [29]	10 [0.5]
H. Sweep	953 [37.5]	1029 [40.5]	1067 [42]	1111 [43.75]	1162 [45.75]	1219 [48]	1283 [50.5]	1340 [52.75]	1397 [55]	1461 [57.5]	1524 [60]	1581 [62.25]	1638 [64.5]	10 [0.5]
J. Collar Depth	83 [3.25]	83 [3.25]	83 [3.25]	83 [3.25]	83 [3.25]	83 [3.25]	83 [3.25]	83 [3.25]	83 [3.25]	83 [3.25]	83 [3.25]	83 [3.25]	83 [3.25]	5 [0.25]
K. Shoulder	133 [5.25]	139 [5.5]	139 [5.5]	146 [5.75]	146 [5.75]	152 [6]	152 [6]	152 [6]	159 [6.25]	165 [6.5]	165 [6.5]	165 [6.5]	171 [6.75]	10 [0.5]

Front

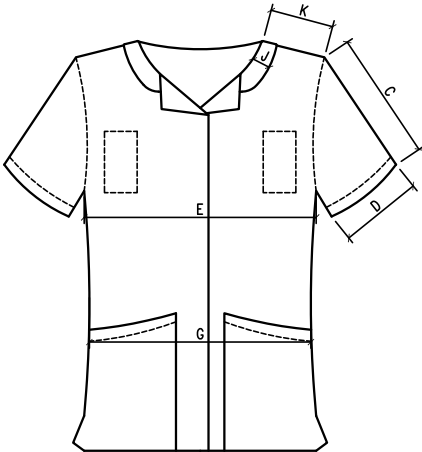

Back

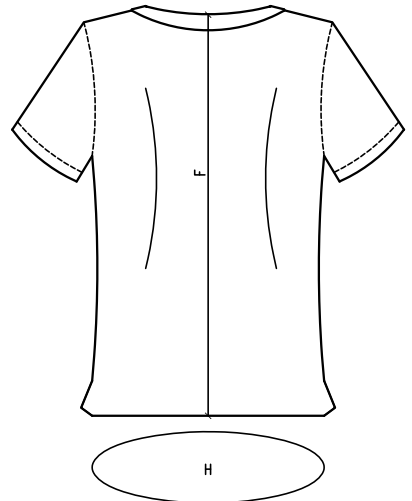

All dimensions in millimetres [inches in brackets].
Drawing not to scale. Dimensions are approximate.





Model is
wearing
Bottle
Green.



If one of your measurements is between two sizes, order the smaller size for a tighter fit or the larger size for a looser fit. If your measurements for hips and waist correspond to two different suggested sizes, order the one indicated by your hip measurement.

Modern Classic / Contemporary Fit

	X Small	Small	Medium	Large	X Large	2X Large	3X Large	Tol. +/-
A. Chest	838 - 864 [33 - 34]	889 - 940 [35 - 37]	965 - 1016 [38 - 40]	1041 - 1118 [41 - 44]	1143 - 1219 [45 - 48]	1245 - 1321 [49 - 52]	1346 - 1422 [53 - 56]	15 [0.5]
B. Waist	635 - 660 [25 - 26]	686 - 737 [27 - 29]	762 - 813 [30 - 32]	838 - 914 [33 - 36]	940 - 1016 [37 - 40]	1041 - 1118 [41 - 44]	1143 - 1219 [45 - 48]	15 [0.5]
C. Hips	864 - 890 [34 - 35]	914 - 965 [36 - 38]	991 - 1041 [39 - 41]	1067 - 1143 [42 - 45]	1168 - 1245 [46 - 49]	1270 - 1346 [50 - 53]	1372 - 1448 [54 - 57]	15 [0.5]
Trousers/Pant: In-seam: Regular 787 [31], Short 724 [29.5], Tall 864 [34] All dimensions are in millimetres [inches in brackets]								

Unisex Fit

	X Small	Small	Medium	Large	X Large	2X Large	3X Large	Tol. +/-
A. Chest	838 - 864 [33 - 34]	890 - 927 [35 - 36.5]	940 - 1003 [37 - 39.5]	1016 - 1092 [40 - 43]	1118 - 1194 [44 - 47]	1232 - 1295 [48.5 - 51]	1321 - 1397 [52 - 55]	15 [0.5]
B. Waist	635 - 675 [25 - 26.5]	686 - 724 [27 - 28.5]	737 - 800 [29 - 31.5]	813 - 889 [32 - 35]	914 - 1003 [36 - 39.5]	1016 - 1092 [40 - 43]	1118 - 1207 [44 - 47.5]	15 [0.5]
C. Hips	889 - 927 [35 - 36.5]	940 - 965 [37 - 38]	991 - 1054 [39 - 41.5]	1067 - 1156 [42 - 45.5]	1168 - 1245 [46 - 49]	1270 - 1359 [50 - 53.5]	1372 - 1461 [54 - 57.5]	15 [0.5]
Trousers/Pant: In-seam: Regular 778 [31.5], Short 711 [28], Tall 851 [33.5] All dimensions are in millimetres [inches in brackets]								

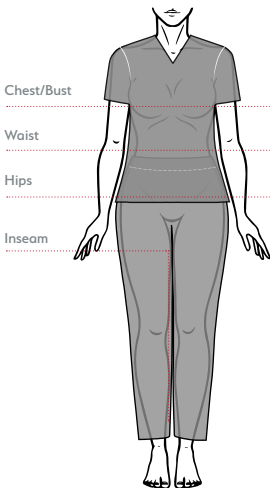

Chest/Bust

Waist

Hips

Inseam

Measure under the arms around the fullest part of the bust/ chest.

Measure under the natural waistline, loosely holding the tape measure.

Measure around the fullest part of the hips.

Measure along the inside of the leg, from just below the crotch to 254mm below the ankle

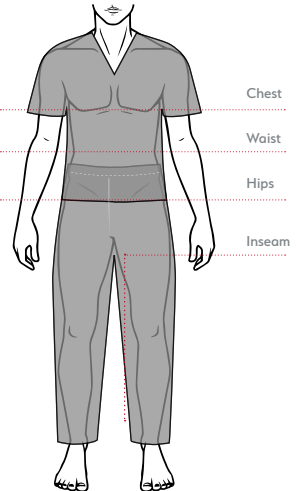

Chest

Waist

Hips

Inseam



Model is
wearing
Eggplant.



MEDICAL



BALANCE

Sizing

If one of your measurements is between two sizes, order the smaller size for a tighter fit or the larger size for a looser fit. If your measurements for hips and waist correspond to two different suggested sizes, order the one indicated by your hip measurement.

Female Fit

	X Small	Small	Medium	Large	X Large	2X Large	3X Large	Tol. +/-
A. Chest	838 - 864 [33 - 34]	889 - 914 [35 - 36]	940 - 991 [37 - 39]	1016 - 1092 [40 - 43]	1118 - 1194 [44 - 47]	1219 - 1295 [48 - 51]	1321 - 1397 [52 - 55]	15 [0.5]
B. Waist	635 - 660 [25 - 26]	686 - 711 [27 - 28]	737 - 787 [29 - 31]	813 - 889 [32 - 35]	914 - 991 [36 - 39]	1016 - 1092 [40 - 43]	1118 - 1194 [44 - 47]	15 [0.5]
C. Hips	889 - 914 [35 - 36]	940 - 965 [37 - 38]	991 - 1041 [39 - 41]	1067 - 1143 [42 - 45]	1168 - 1245 [46 - 49]	1270 - 1346 [50 - 53]	1372 - 1449 [54 - 57]	15 [0.5]
Trousers/Pant: In-seam: Regular 762 - 787 [30 - 31], Short 699 - 724 [27.5 - 28.5], Tall 838 - 864 [33 - 34] All dimensions are in millimetres [inches in brackets]								

Male Fit

	X Small	Small	Medium	Large	X Large	2X Large	3X Large	Tol. +/-
A. Chest	840 - 890 [33 - 35]	915 - 965 [36 - 38]	990 - 1040 [39 - 41]	1070 - 1145 [42 - 45]	1170 - 1250 [46 - 49]	1270 - 1345 [50 - 53]	1370 - 1450 [54 - 57]	15 [0.5]
B. Waist	610 - 660 [24 - 26]	685 - 735 [27 - 29]	760 - 815 [30 - 32]	840 - 915 [33 - 36]	940 - 1015 [37 - 40]	1040 - 1120 [41 - 44]	1145 - 1220 [45 - 48]	15 [0.5]
C. Hips	840 - 890 [33 - 35]	915 - 965 [36 - 38]	990 - 1040 [39 - 41]	1070 - 1145 [42 - 45]	1170 - 1250 [46 - 49]	1270 - 1345 [50 - 53]	1370 - 1450 [54 - 57]	15 [0.5]
Trousers/Pant: In-seam: Regular 810 [32] All dimensions are in millimetres [inches in brackets]								

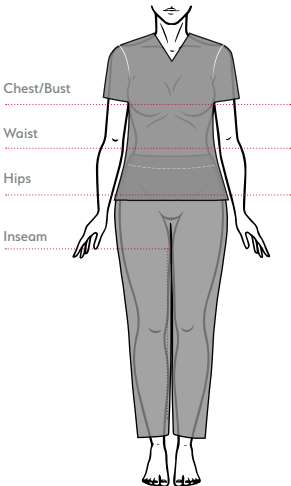

Measure under the arms around the fullest part of the bust/ chest.
 Measure under the natural waistline, loosely holding the tape measure.
 Measure around the fullest part of the hips.
 Measure along the inside of the leg, from just below the crotch to 254mm below the ankle

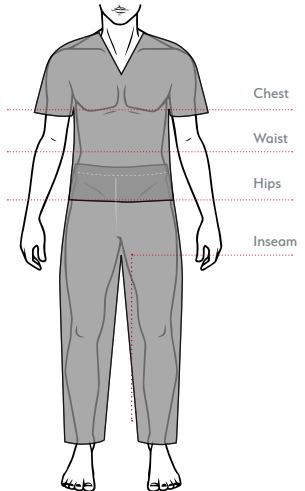



Model is wearing Wine.

If one of your measurements is between two sizes, order the smaller size for a tighter fit or the larger size for a looser fit. If your measurements for hips and waist correspond to two different suggested sizes, order the one indicated by your hip measurement.

Female

	X Small	Small	Medium	Large	X Large	2X Large	Tol. +/-
A. Chest	838 - 864 [33 - 34]	889 - 914 [35 - 36]	940 - 991 [37 - 39]	1016 - 1067 [40 - 42]	1092 - 1143 [43 - 45]	1168 - 1219 [46 - 48]	15 [0.5]
B. Waist	648 - 673 [25.5 - 26.5]	699 - 711 [27.5 - 28]	749 - 800 [29.5 - 31.5]	826 - 876 [32.5 - 34.5]	902 - 953 [35.5 - 37.5]	991 - 1041 [39 - 41]	15 [0.5]
C. Hips	914 - 940 [36 - 37]	965 - 991 [38 - 39]	1016 - 1067 [40 - 42]	1092 - 1143 [43 - 45]	1168 - 1219 [46 - 48]	1245 - 1295 [49 - 51]	15 [0.5]
All dimensions are in millimetres [inches in brackets]							

Unisex

	X Small	Small	Medium	Large	X Large	2X Large	Tol. +/-
A. Chest	838 - 889 [33 - 35]	914 - 965 [36 - 38]	991 - 1041 [39 - 41]	1092 - 1143 [43 - 45]	1194 - 1245 [47 - 49]	1295 - 1346 [51 - 53]	15 [0.5]
B. Waist	673 - 711 [26.5 - 28]	749 - 800 [29.5 - 31.5]	838 - 876 [33 - 34.5]	927 - 978 [36.5 - 38.5]	1029 - 1080 [40.5 - 42.5]	1130 - 1181 [44.5 - 46.5]	15 [0.5]
All dimensions are in millimetres [inches in brackets]							

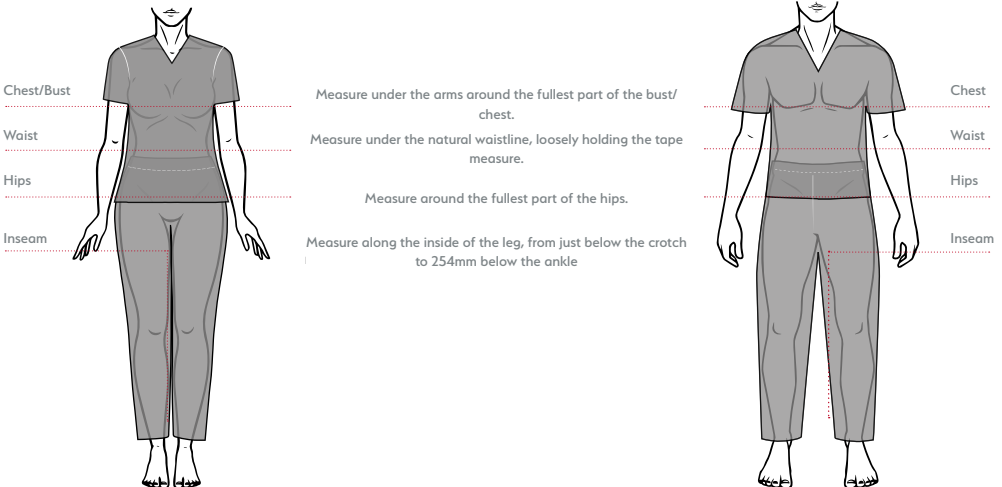



Model is
wearing
Turquoise.

If one of your measurements is between two sizes, order the smaller size for a tighter fit or the larger size for a looser fit. If your measurements for hips and waist correspond to two different suggested sizes, order the one indicated by your hip measurement.

Women's Fit

	X Small	Small	Medium	Large	X Large	2X Large	3X Large	Tol. +/-
A. Chest	838 - 864 [33 - 34]	889 - 914 [35 - 36]	940 - 991 [37 - 39]	1016 - 1092 [40 - 43]	1118 - 1194 [44 - 47]	1219 - 1295 [48 - 51]	1321 - 1397 [52 - 55]	15 [0.5]
B. Waist	635 - 660 [25 - 26]	686 - 711 [27 - 28]	737 - 787 [29 - 31]	815 - 889 [32 - 35]	914 - 991 [36 - 39]	1016 - 1092 [40 - 43]	1118 - 1194 [44 - 47]	15 [0.5]
C. Hips	889 - 914 [35 - 36]	940 - 965 [37 - 38]	991 - 1041 [39 - 41]	1067 - 1143 [42 - 45]	1168 - 1245 [46 - 49]	1270 - 1346 [50 - 53]	1372 - 1448 [54 - 57]	15 [0.5]
Trousers/Pant: In-seam: Regular 775 [30.5]								
All dimensions are in millimetres [inches in brackets]								

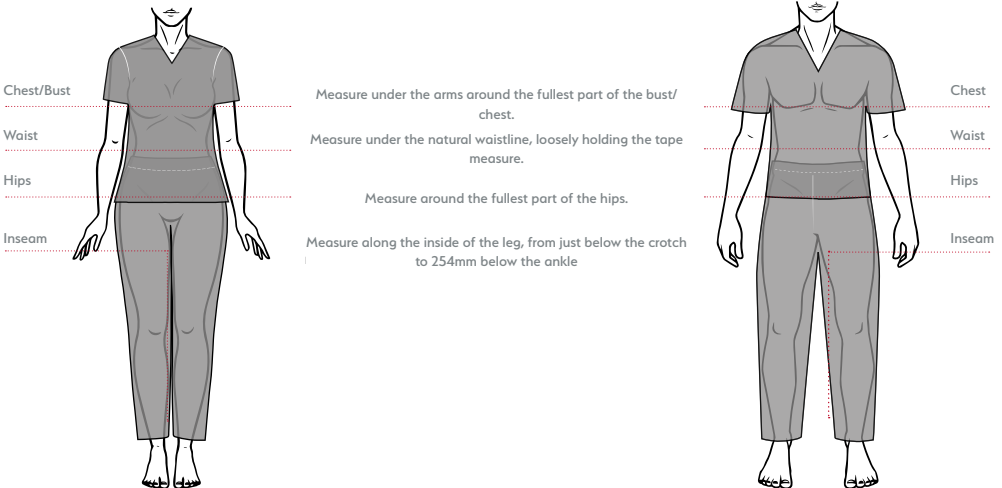



Model is
wearing
Eggplant.



Female Tunic Tops - 0400 & 0500

	X Small	Small	Medium	Large	X Large	2X Large	3X Large	Tol. +/-
A. Neck Width	190 [7.5]	190 [7.5]	195 [7.75]	200 [8]	215 [8.5]	220 [8.75]	230 [9]	5 [0.25]
B. Front Neck Drop	155 [6]	160 [6.25]	165 [6.5]	170 [6.75]	175 [7]	175 [7]	175 [7]	5 [0.25]
C. Sleeve Length	180 [7]	185 [7.25]	195 [7.75]	200 [8]	210 [8.25]	220 [8.75]	225 [9]	12.5 [0.5]
D. Chest/Bust	980 [38.5]	1010 [39.75]	1080 [42.5]	1150 [45.25]	1250 [49.25]	1350 [53]	1430 [56.25]	25 [1]
E. Back Length	630 [24.75]	645 [25.5]	660 [26]	675 [26.5]	685 [27]	705 [27.75]	715 [28]	25 [1]
F. Sweep	1050 [41.25]	1090 [43]	1160 [45.75]	1240 [48.75]	1310 [51.5]	1420 [56]	1500 [59]	25 [1]

Dimensions are approximate. All dimensions are in millimetres [inches in brackets]. Drawings are not to scale

Female Trousers - 0600 & 0700

	X Small	Small	Medium	Large	X Large	2X Large	3X Large	Tol. +/-
A. Waist Relaxed	690 [27.25]	740 [29]	800 [31.5]	850 [33.5]	910 [35.75]	970 [38.25]	1050 [41.25]	25 [1]
B. Waist Extended	860 [34]	900 [35.5]	1000 [39.5]	1060 [41.75]	1140 [44.5]	1220 [48]	1360 [53.5]	25 [1]
C. Hips (200mm down from waist)	940 [37]	970 [38.25]	1100 [42.25]	1120 [44]	1200 [47.25]	1360 [53.5]	1420 [56]	12.5 [0.5]
D. Inseam 0600 Standard	770 [30.25]	770 [30.25]	770 [30.25]	770 [30.25]	770 [30.25]	775 [30.5]	775 [30.5]	12.5 [0.5]
E. Inseam 0700 Jogger	720 [28.25]	720 [28.25]	720 [28.25]	720 [28.25]	720 [28.25]	725 [28.5]	725 [28.5]	12.5 [0.5]

Dimensions are approximate. All dimensions are in millimetres [inches in brackets]. Drawings are not to scale

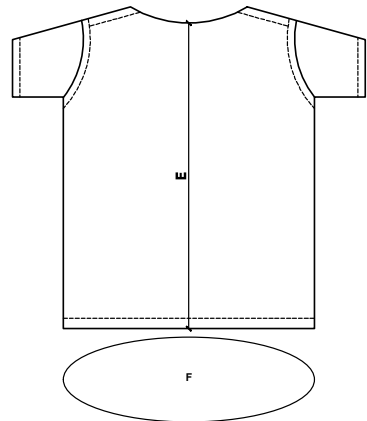
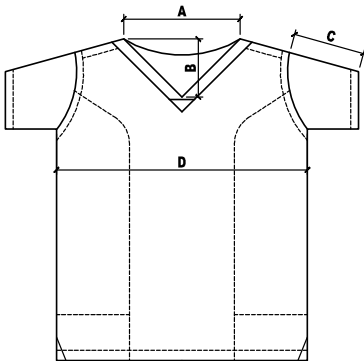

Male Tunic Top - 0300

	X Small	Small	Medium	Large	X Large	2X Large	3X Large	Tol. +/-
A. Neck Width	170 [6.75]	175 [7]	180 [7.25]	190 [7.5]	205 [8]	210 [8.25]	215 [8.5]	5 [0.25]
B. Front Neck Drop	160 [6.5]	160 [6.5]	160 [6.5]	170 [6.75]	175 [7]	180 [7.25]	180 [7.25]	5 [0.25]
C. Sleeve Length	235 [9.25]	235 [9.25]	235 [9.25]	235 [9.25]	235 [9.25]	240 [9.5]	240 [9.5]	12.5 [0.5]
D. Chest/Bust	980 [38.5]	1040 [41]	1100 [43.25]	1220 [48]	1320 [52]	1340 [52.75]	1380 [54.25]	25 [1]
E. Back Length	720 [28.25]	730 [28.75]	740 [29]	750 [29.5]	765 [30]	780 [30.75]	795 [31.25]	25 [1]
F. Sweep	960 [37.75]	1020 [40.25]	1100 [43.25]	1220 [48]	1320 [52]	1340 [52.75]	1380 [54.25]	25 [1]

Dimensions are approximate. All dimensions are in millimetres [inches in brackets]. Drawings are not to scale

Male Trousers - 0100 & 0200

	X Small	Small	Medium	Large	X Large	2X Large	3X Large	Tol. +/-
A. Waist Relaxed	640 [25]	690 [27]	760 [30]	840 [33]	960 [37.5]	980 [38.5]	1060 [42]	25 [1]
B. Waist Extended	890 [35]	980 [37.5]	1040 [41]	1150 [45.5]	1280 [50.5]	1320 [52]	1360 [53.5]	25 [1]
C. Hips (200mm down from waist)	962 [38]	1010 [40]	1070 [42]	1146 [45]	1302 [51.5]	1260 [49.5]	1354 [53.5]	12.5 [0.5]
D. Inseam 0100 Jogger	765 [30]	765 [30]	765 [30]	765 [30]	770 [30.5]	770 [30.5]	770 [30.5]	12.5 [0.5]
E. Inseam 0200 Standard	815 [32]	815 [32]	815 [32]	815 [32]	820 [32.5]	820 [32.5]	820 [32.5]	12.5 [0.5]

Dimensions are approximate. All dimensions are in millimetres [inches in brackets]. Drawings are not to scale

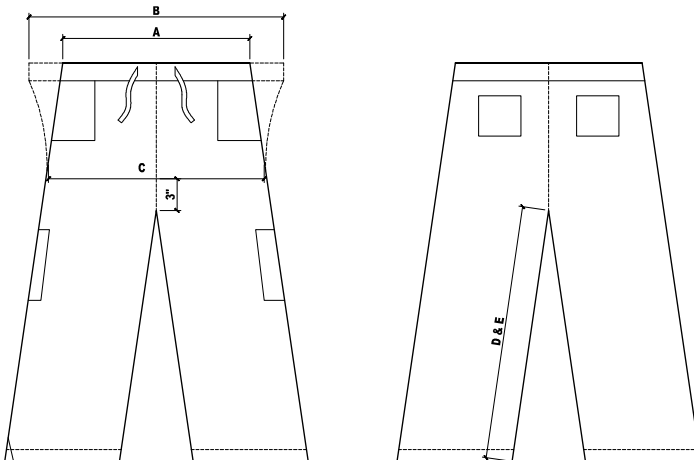

If one of your measurements is between two sizes, order the smaller size for a tighter fit or the larger size for a looser fit. If your measurements for hips and waist correspond to two different suggested sizes, order the one indicated by your hip measurement.

Female Fit

	X Small	Small	Medium	Large	X Large	2X Large	3X Large	Tol. +/-
A. Chest	830 - 870 [33 - 34]	880 - 920 [35 - 36]	930 - 1000 [37 - 39]	1010 - 1100 [40 - 43]	1110 - 1190 [44 - 47]	1210 - 1300 [48 - 51]	1310 - 1400 [52 - 55]	15 [0.5]
B. Waist	630 - 670 [25 - 26]	680 - 720 [27 - 28]	730 - 800 [29 - 31]	810 - 890 [32 - 35]	900 - 990 [36 - 39]	1010 - 1100 [40 - 43]	1110 - 1200 [44 - 47]	15 [0.5]
C. Hips	880 - 920 [35 - 36]	930 - 980 [37 - 38]	990 - 1050 [39 - 41]	1060 - 1150 [42 - 45]	1160 - 1240 [46 - 49]	1260 - 1350 [50 - 53]	1360 - 1450 [54 - 57]	15 [0.5]
All dimensions are in millimetres [inches in brackets]								

Male Fit

	X Small	Small	Medium	Large	X Large	2X Large	3X Large	Tol. +/-
A. Chest	840 - 890 [33-35]	900 - 970 [36 - 38]	980 - 1050 [39 - 41]	1060 - 1150 [42 - 44]	1140 - 1250 [45 - 48]	1240 - 1350 [49 - 52]	1340 - 1450 [53 - 56]	15 [0.5]
B. Waist	610 - 670 [24 - 26]	680 - 740 [27 - 29]	750 - 820 [30 - 32]	830 - 900 [33 - 35]	910 - 1000 [36 - 39]	1010 - 1110 [40 - 43]	1110 - 1200 [44 - 47]	15 [0.5]
C. Hips	840 - 890 [33 - 35]	900 - 970 [36 - 38]	980 - 1050 [39 - 41]	1060 - 1150 [42 - 44]	1140 - 1250 [45 - 48]	1240 - 1350 [49 - 52]	1340 - 1450 [53 - 56]	15 [0.5]
All dimensions are in millimetres [inches in brackets]								

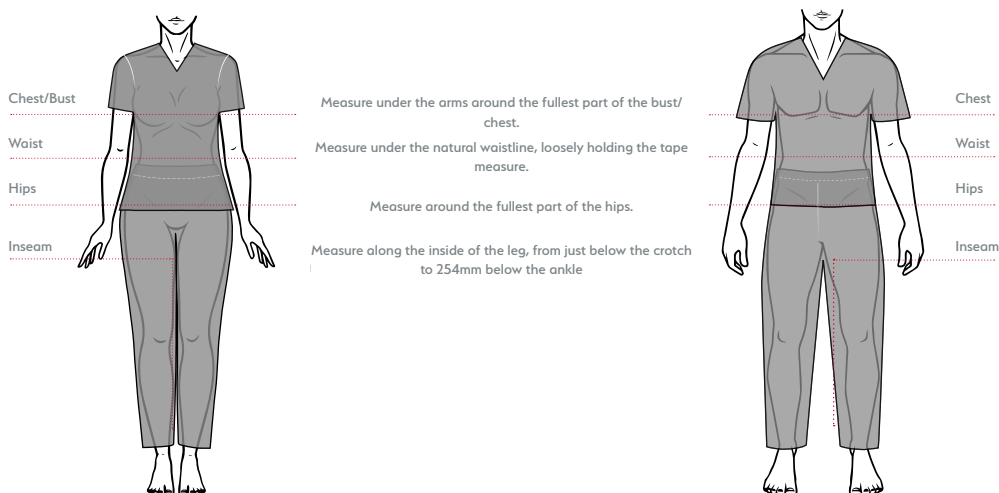



Model is
wearing
Eggplant.





Healing
Hands®

Female sizing

If one of your measurements is between two sizes, order the smaller size for a tighter fit or the larger size for a looser fit. If your measurements for hips and waist correspond to two different suggested sizes, order the one indicated by your hip measurement.

HH Works

	X Small	Small	Medium	Large	X Large	2X Large	Tol. +/-
A. Chest	815 - 838 [32 - 33]	864 - 889 [34 - 35]	914 - 940 [36 - 37]	965 - 1016 [38 - 40]	1041 - 1092 [41 - 43]	1194 - 1245 [47 - 49]	15 [0.5]
B. Waist	610 - 635 [24 - 25]	660 - 686 [26 - 27]	711 - 762 [28 - 30]	787 - 838 [31 - 33]	864 - 914 [34 - 36]	991 - 1041 [39 - 41]	15 [0.5]
C. Hips	914 - 940 [36 - 37]	914 - 940 [36 - 37]	965 - 1016 [38 - 40]	1041 - 1092 [41 - 43]	1118 - 1168 [44 - 46]	1245 - 1295 [49 - 51]	15 [0.5]
Trousers/Pant: In-seam: Regular 787 [31], Short 737 [29], Tall 838 [33] All dimensions are in millimetres [inches in brackets]							

Purple Label & 360

	X Small	Small	Medium	Large	X Large	2X Large	Tol. +/-
A. Chest	762 - 838 [30 - 33]	838 - 889 [33 - 35]	889 - 940 [35 - 37]	940 - 1016 [37 - 40]	1016 - 1092 [40 - 43]	1092 - 1194 [43 - 47]	15 [0.5]
B. Waist	610 - 660 [24 - 26]	660 - 711 [26 - 28]	711 - 762 [28 - 30]	762 - 838 [28 - 33]	838 - 914 [33 - 36]	914 - 1016 [36 - 40]	15 [0.5]
C. Hips	864 - 914 [34 - 36]	914 - 965 [36 - 38]	965 - 1016 [38 - 40]	1016 - 1092 [40 - 43]	1092 - 1168 [43 - 46]	1168 - 1270 [46 - 50]	15 [0.5]
Trousers/Pant: In-seam: Regular 787 [31], Short 737 [29], Tall 838 [33] All dimensions are in millimetres [inches in brackets]							

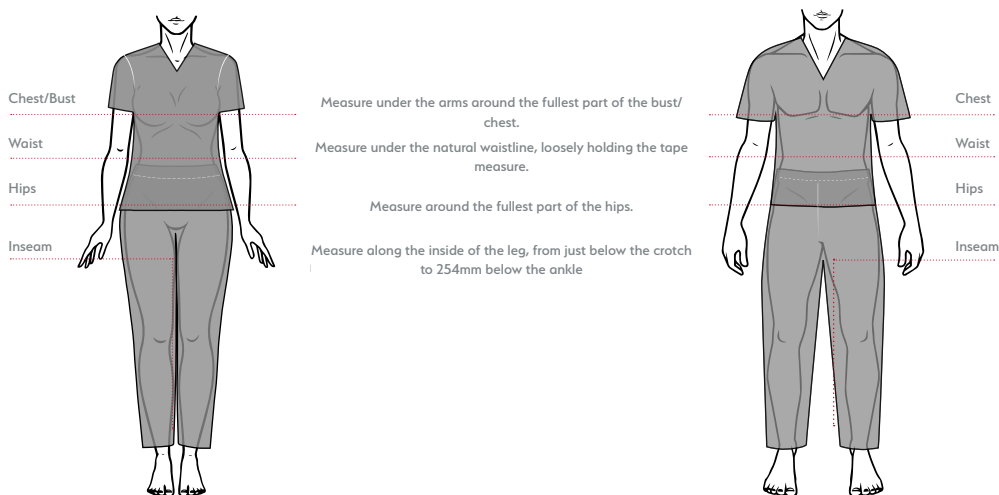



Model is
wearing
Navy



Healing
Hands®

Male sizing

If one of your measurements is between two sizes, order the smaller size for a tighter fit or the larger size for a looser fit. If your measurements for hips and waist correspond to two different suggested sizes, order the one indicated by your hip measurement.

HH Works, Purple Label & 360

	X Small	Small	Medium	Large	X Large	2X Large	Tol. +/-
A. Chest	813 - 864 [32 - 34]	914 - 940 [36 - 37]	965 - 1016 [38 - 40]	1067 - 1118 [42 - 44]	1168 - 1219 [46 - 48]	1270 - 1422 [50 - 56]	15 [0.5]
B. Waist	686 - 711 [27 - 28]	737 - 787 [29 - 31]	813 - 864 [32 - 34]	889 - 965 [35 - 38]	991 - 1067 [39 - 42]	1092 - 1168 [43 - 46]	15 [0.5]
C. Hips	813 - 864 [32 - 34]	889 - 940 [35 - 37]	965 - 1016 [38 - 40]	1041 - 1118 [41 - 44]	1143 - 1219 [45 - 48]	1245 - 1321 [49 - 52]	15 [0.5]
Trousers/Pant: In-seam: Regular 813 [32], Short 749 [29.5], Tall 889 [35] All dimensions are in millimetres [inches in brackets]							

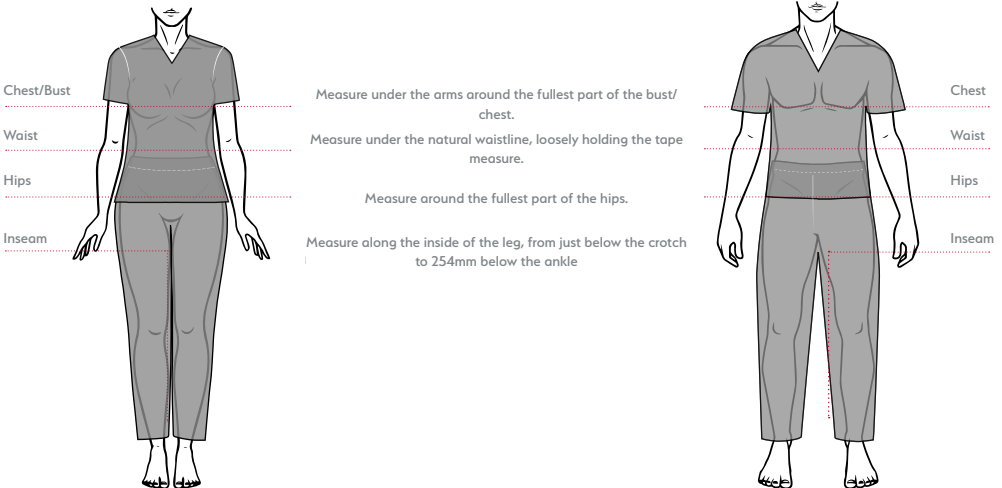



Model is
wearing
Navy.



Under-scrubs base-layer.

Male and Female fit. Peppermint extract gives a natural deodorising finish without a mint-scent. Can also be used for modesty. Lightweight, seamless body with unique jacquard pattern. Breathable 4-way stretch for easy movement and all day comfort. Durable, crease resistant and easy-care.

Female
under-scrub available sizes:
XS S M L XL

available colours:

Male
under-scrub available sizes:
S M L XL 2XL

available colours:



Personalise your work-wear with our custom in-house embroidery



- add your own logo
- add your and your team's name
- a wide range of fonts and colours
- for bespoke requirements, please get in touch & visit our [embroidery page](#).

multi-coloured logos

